

# DRAX



## DRAX INC Product Specification

Designed by Science



32  
33

DRAX

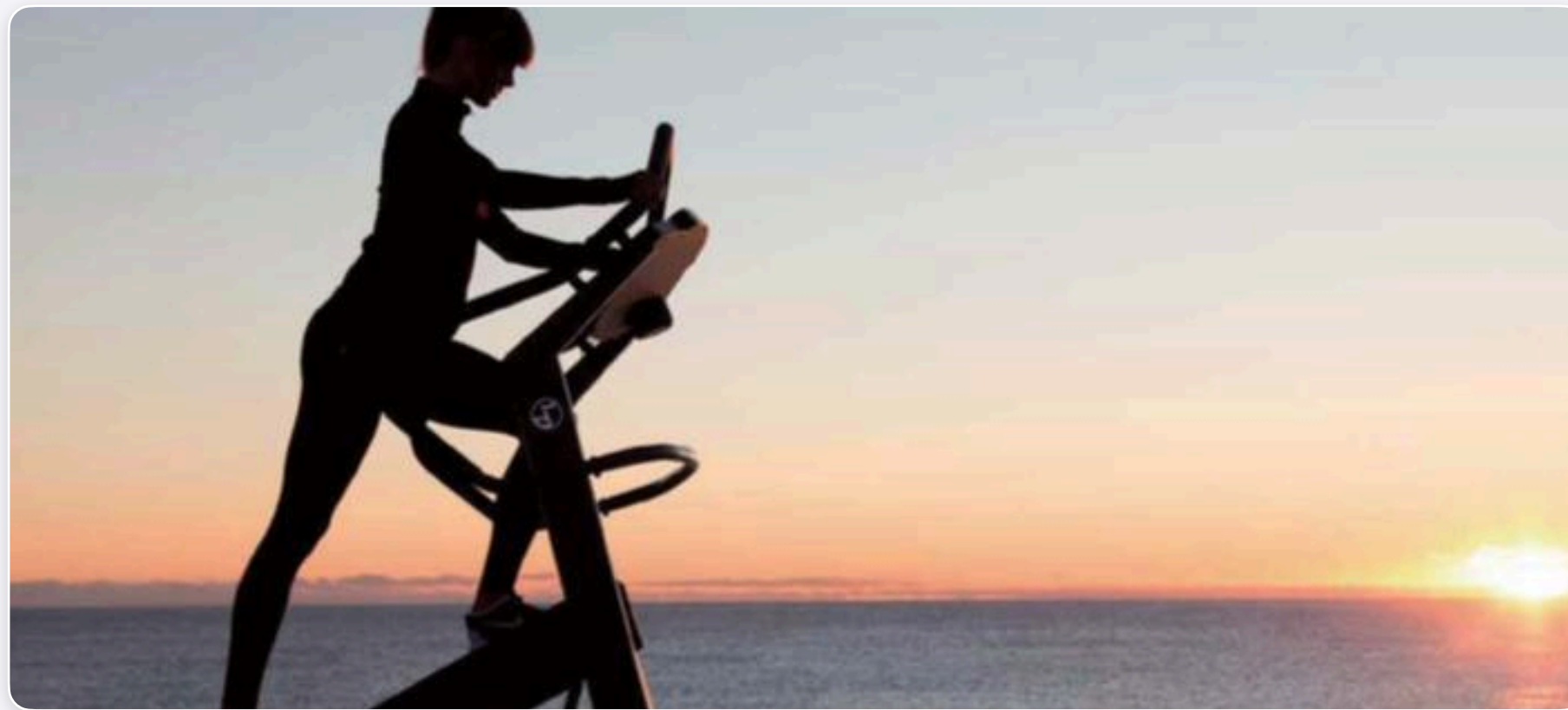

## Drax Cardio Equipment





## RX7700



### KEY FEATURES

- **Floating Deck** Technology Patented system provides force reduction to the exerciser. (Patents No. 10-1371607)
- **Simple LED Console** with programs and quick keys. Multiple data displays and LED workout profile graph
- **Optional Attachable TV Brackets** available

<b>Speed</b>	• 0.8 ~ 16 kph (0.1 kph increments) 0.5 ~ 10 mph
<b>Incline</b>	• 0 ~ 15 % (0.1% increments) Dual Axle System
<b>Motor Duty</b>	• AC 3HP (Continuous Duty)
<b>AC Motor Control</b>	• Fuji Inverter Control
<b>Roller Diameter</b>	• 100 mm / 4"
<b>Running Space</b>	• 1620 x x 520 mm (L x W) 64 inches x 20 inches
<b>Max. User Weight</b>	• 180 kg / 397 lbs
<b>Product Weight</b>	• 200 kg / 440 lbs
<b>Display</b>	• 3 color Dot Matrix
<b>Console Display</b>	• Speed, Incline, Time, Distance, Calorie, Heart Rate
<b>Electricity</b>	• 220V (50/60Hz) 10 AMP Dedicated Outlet
<b>Warranty</b>	• Warranty 2 yrs, Wear items 6 months
<b>Packing Size</b>	• 2220 x 970 x 745 mm (LxWxH), 1.6 cbm, • Net Weight 200Kg, Gross Weight 220Kg



## RX9200



### KEY FEATURES

- **Floating Deck Technology** Patented system provides force reduction to the exerciser. (Patents No. 10-1371607)
- **Dual Incline System** Patented system reduces the load on the incline motor by at least 50 %. This drastically extends the life of the incline motor and lifting mechanism and provides a very quiet system without any rolling while running. (Patents No. 10-0624647)
- **Simple LED Console** with programs and quick keys. Multiple data displays and LED workout profile graph
- **Optional Attachable TV Brackets** available

<b>Speed</b>	• 0.8 ~ 16 kph (0.1 kph increments) 0.5 ~ 10 mph
<b>Incline</b>	• 0 ~ 16 % (0.1% increments) Dual Axle System
<b>Motor Duty</b>	• AC 3HP (Continuous Duty)
<b>AC Motor Control</b>	• Fuji Inverter Control
<b>Roller Diameter</b>	• 100 mm / 4"
<b>Running Space</b>	• 1620 x x 520 mm (L x W) 64 inches x 20 inches
<b>Max. User Weight</b>	• 180 kg / 397 lbs
<b>Product Weight</b>	• 200 kg / 440 lbs
<b>Display</b>	• 3 color Dot Matrix
<b>Console Display</b>	• Speed, Incline, Time, Distance, Calorie, Heart Rate
<b>Exercise Program</b>	• 12 Preset Programs
<b>Heart Rate</b>	• Polar Compatible Wireless Heart Rate, Hand Sensor Heart Rate Contacts
<b>Electricity</b>	• 220V (50/60Hz) 10 AMP Dedicated Outlet
<b>Warranty</b>	• Warranty 2 yrs, Wear items 6 months
<b>Packing Size</b>	• 2220 x 970 x 745 mm (LxWxH), 1.6 cbm, • Net Weight 200Kg, Gross Weight 220Kg



# NRED20X / NRED20SX



## KEY FEATURES



- **Floating Deck Technology** Patented system provides force reduction to the exerciser. (Patents No. 10-1371607)
- **Dual Incline System** Patented system reduces the load on the incline motor by at least 50 %. This drastically extends the life of the incline motor and lifting mechanism and provides a very quiet system without any rolling while running. (Patents No. 10-0624647)

<b>NRED20X</b>	• Speed 0.8 ~ 20 kph (0.5 ~ 12.5 mph), Incline 0 ~ 16 %
<b>NRED20SX</b>	• Speed 0.8 ~ 20 kph (0.5 ~ 12.5 mph), Incline 0 ~ 16 % + SPEEDSYNC (Automatic speed adjustment)
<b>Motor Duty</b>	• AC 3HP (Treadmill Duty)
<b>AC Motor Control</b>	• Fuji Inverter Control
<b>Roller Diameter</b>	• 100 mm / 4"
<b>Running Space</b>	• 1620 x x 520 mm (L x W) 64 inches x 20 inches
<b>Max. User Weight</b>	• 180 kg / 397 lbs
<b>Product Weight</b>	• 200 kg / 440 lbs
<b>Console Display</b>	• Speed, Incline, Time, Distance, Calorie, Heart Rate
<b>Exercise Program</b>	• Time/Distance/Calorie Target Goal Programs
<b>Heart Rate</b>	• Hand Sensor Heart Rate Contacts, Compatible Wireless Heart Rate (Option)
<b>Electricity</b>	• 220V (50/60Hz) 10 AMP Dedicated Outlet
<b>Warranty</b>	• Warranty 2 yrs, Wear items 6 months, TV Panel 1 year
<b>Product Size</b>	• 2165 x 928 x 1645mm (LxWxH)
<b>Packing Size</b>	• 2220 x 970 x 745 mm (LxWxH), 1.6 cbm, • Net Weight 200Kg, Gross Weight 220Kg



# NRED25X / NRED25SX



## KEY FEATURES



- **Floating Deck Technology** Patented system provides force reduction to the exerciser. (Patents No. 10-1371607)
- **Dual Incline System** Patented system reduces the load on the incline motor by at least 50 %. This drastically extends the life of the incline motor and lifting mechanism and provides a very quiet system without any rolling while running. (Patents No. 10-0624647)

<b>NRED25X</b>	• Speed 0.8 ~ 25 kph (0.5 ~ 15.5 mph), Incline 0 ~ 16 %
<b>NRED25SX</b>	• Speed 0.8 ~ 25 kph (0.5 ~ 15.5 mph), Incline 0 ~ 16 % + SPEEDSYNC (Automatic speed adjustment)
<b>Motor Duty</b>	• AC 5HP (Treadmill Duty)
<b>AC Motor Control</b>	• Fuji Inverter Control
<b>Roller Diameter</b>	• 100 mm / 4"
<b>Running Space</b>	• 1620 x x 520 mm (L x W) 64 inches x 20 inches
<b>Max. User Weight</b>	• 180 kg / 397 lbs
<b>Product Weight</b>	• 200 kg / 440 lbs
<b>Console Display</b>	• Speed, Incline, Time, Distance, Calorie, Heart Rate
<b>Exercise Program</b>	• Time/Distance/Calorie Target Goal Programs
<b>Heart Rate</b>	• Hand Sensor Heart Rate Contacts, Compatible Wireless Heart Rate (Option)
<b>Electricity</b>	• 220V (50/60Hz) 10 AMP Dedicated Outlet
<b>Warranty</b>	• Warranty 2 yrs, Wear items 6 months, TV Panel 1 year
<b>Product Size</b>	• 2165 x 928 x 1645mm (LxWxH)
<b>Packing Size</b>	• 2220 x 970 x 745 mm (LxWxH), 1.6 cbm, • Net Weight 200Kg, Gross Weight 220Kg

# NR20X



## KEY FEATURES

- **Smart Device Mirroring** Allows the exerciser to mirror their Smart device onto the 21.5 inch display screen. Supports both iOS and Android devices.
- **Floating Deck Technology** Patented system provides force reduction to the exerciser. (Patents No. 10-1371607)
- **Dual Incline System** Patented system reduces the load on the incline motor by at least 50 %. This drastically extends the life of the incline motor and lifting mechanism and provides a very quiet system without any rolling while running. (Patents No. 10-0624647)

<b>Speed</b>	• 0.8 ~ 20 kph (0.1 kph increments) 0.5 ~ 12.5 mph
<b>Incline</b>	• 0 ~ 16 % (0.1% increments) Dual Axle System
<b>Motor Duty</b>	• AC 3HP (Treadmill Duty)
<b>AC Motor Control</b>	• Fuji Inverter Control
<b>Roller Diameter</b>	• 100 mm / 4"
<b>Running Space</b>	• 1620 x x 520 mm (L x W) 64 inches x 20 inches
<b>Max. User Weight</b>	• 180 kg / 397 lbs
<b>Product Weight</b>	• 200 kg / 440 lbs
<b>Entertainment</b>	<ul style="list-style-type: none"> <li>• 21.5 inches Display Panel (HDTV Supported)</li> <li>• Smartphone Display Mirroring to Monitor (Android &amp; iOS)</li> <li>• USB Charge port</li> <li>• Wired Headphone Jack</li> </ul>
<b>Console Display</b>	• Speed, Incline, Time, Distance, Calorie, Heart Rate
<b>Exercise Program</b>	• Time/Distance/Calorie Target Goal Programs
<b>Heart Rate</b>	• Hand Sensor Heart Rate Contacts, Compatible Wireless Heart Rate (Option)
<b>Electricity</b>	• 220V (50/60Hz) 10 AMP Dedicated Outlet
<b>Warranty</b>	• Warranty 2 yrs, Wear items 6 months, TV Panel 1 year
<b>Product Size</b>	• 2165 x 928 x 1645mm (LxWxH)
<b>Packing Size</b>	• 2220 x 970 x 745 mm (LxWxH), 1.6 cbm, • Net Weight 200Kg, Gross Weight 220Kg



# NR25X



## KEY FEATURES

- **Smart Device Mirroring** Allows the exerciser to mirror their Smart device onto the 21.5 inch display screen. Supports both iOS and Android devices.
- **Floating Deck Technology** Patented system provides force reduction to the exerciser. (Patents No. 10-1371607)
- **Dual Incline System** Patented system reduces the load on the incline motor by at least 50 %. This drastically extends the life of the incline motor and lifting mechanism and provides a very quiet system without any rolling while running. (Patents No. 10-0624647)

<b>Speed</b>	• 0.8 ~ 25 kph (0.1 kph increments) 0.5 ~ 15.5 mph
<b>Incline</b>	• 0 ~ 16 % (0.1% increments) Dual Axle System
<b>Motor Duty</b>	• AC 5HP (Treadmill Duty)
<b>AC Motor Control</b>	• Fuji Inverter Control
<b>Roller Diameter</b>	• 100 mm / 4"
<b>Running Space</b>	• 1620 x x 520 mm (L x W) 64 inches x 20 inches
<b>Max. User Weight</b>	• 180 kg / 397 lbs
<b>Product Weight</b>	• 200 kg / 440 lbs
<b>Entertainment</b>	<ul style="list-style-type: none"> <li>• 21.5 inches Display Panel (HDTV Supported)</li> <li>• Smartphone Display Mirroring to Monitor (Android &amp; iOS)</li> <li>• USB Charge port</li> <li>• Wired Headphone Jack</li> </ul>
<b>Console Display</b>	• Speed, Incline, Time, Distance, Calorie, Heart Rate
<b>Exercise Program</b>	• Time/Distance/Calorie Target Goal Programs
<b>Heart Rate</b>	• Hand Sensor Heart Rate Contacts, Compatible Wireless Heart Rate (Option)
<b>Electricity</b>	• 220V (50/60Hz) 10 AMP Dedicated Outlet
<b>Warranty</b>	• Warranty 2 yrs, Wear items 6 months, TV Panel 1 year
<b>Product Size</b>	• 2165 x 928 x 1645mm (LxWxH)
<b>Packing Size</b>	• 2220 x 970 x 745 mm (LxWxH), 1.6 cbm, • Net Weight 200Kg, Gross Weight 220Kg





# NR30X



## KEY FEATURES

- **Smart Device Mirroring** Allows the exerciser to mirror their Smart device onto the 21.5 inch display screen. Supports both iOS and Android devices.
- **Floating Deck Technology** Patented system provides force reduction to the exerciser. (Patents No. 10-1371607)
- **Dual Incline System** Patented system reduces the load on the incline motor by at least 50 %. This drastically extends the life of the incline motor and lifting mechanism and provides a very quiet system without any rolling while running. (Patents No. 10-0624647)

<b>Speed</b>	• 0.8 ~ 25 kph (0.1 kph increments) 0.5 ~ 15.5 mph
<b>Incline</b>	• 0 ~ 22 % (0.1% increments) Dual Axle System
<b>Motor Duty</b>	• AC 5HP (Treadmill Duty)
<b>AC Motor Control</b>	• Fuji Inverter Control
<b>Roller Diameter</b>	• 100 mm / 4"
<b>Running Space</b>	• 1620 x x 520 mm (L x W) 64 inches x 20 inches
<b>Max. User Weight</b>	• 180 kg / 397 lbs
<b>Product Weight</b>	• 200 kg / 440 lbs
<b>Entertainment</b>	<ul style="list-style-type: none"> <li>• 21.5 inches Display Panel (HDTV Supported)</li> <li>• Smartphone Display Mirroring to Monitor (Android &amp; iOS)</li> <li>• USB Charge port</li> <li>• Wired Headphone Jack</li> </ul>
<b>Console Display</b>	• Speed, Incline, Time, Distance, Calorie, Heart Rate
<b>Exercise Program</b>	• Time/Distance/Calorie Target Goal Programs
<b>Heart Rate</b>	• Hand Sensor Heart Rate Contacts, Compatible Wireless Heart Rate (Option)
<b>Electricity</b>	• 220V (50/60Hz) 10 AMP Dedicated Outlet
<b>Warranty</b>	• Warranty 2 yrs, Wear items 6 months, TV Panel 1 year
<b>Product Size</b>	• 2165 x 928 x 1645mm (LxWxH)
<b>Packing Size</b>	• 2220 x 970 x 745 mm (LxWxH), 1.6 cbm, • Net Weight 200Kg, Gross Weight 220Kg



# NR20XA



## KEY FEATURES

- **Smart Device Mirroring** Allows the exerciser to mirror their Smart device onto the 21.5 inch display screen. Supports both iOS and Android devices.
- **Floating Deck Technology** Patented system provides force reduction to the exerciser. (Patents No. 10-1371607)
- **Dual Incline System** Patented system reduces the load on the incline motor by at least 50 %. This drastically extends the life of the incline motor and lifting mechanism and provides a very quiet system without any rolling while running. (Patents No. 10-0624647)

<b>Speed</b>	• 0.8 ~ 20 kph (0.1 kph increments) 0.5 ~ 12.5 mph
<b>Incline</b>	• 0 ~ 16 % (0.1% increments) Dual Axle System
<b>Motor Duty</b>	• AC 3HP (Treadmill Duty)
<b>AC Motor Control</b>	• Fuji Inverter Control
<b>Roller Diameter</b>	• 100 mm / 4"
<b>Running Space</b>	• 1620 x x 520 mm (L x W) 64 inches x 20 inches
<b>Max. User Weight</b>	• 180 kg / 397 lbs
<b>Product Weight</b>	• 200 kg / 440 lbs
<b>Entertainment</b>	<ul style="list-style-type: none"> <li>• 21.5 inches Display Panel (HDTV Supported)</li> <li>• Touch Screen System with Android OS</li> <li>• Smartphone Display Mirroring to Monitor (Android &amp; iOS)</li> <li>• USB Charge port, Wired Headphone Jack, Bluetooth Connectivity (only for Wireless Headphone)</li> <li>• Virtual Street Views of 8 European Cities</li> </ul>
<b>Internet</b>	• Wired and Wireless Connectivity
<b>Console Display</b>	• Speed, Incline, Time, Distance, Calorie, Heart Rate
<b>Exercise Program</b>	• 12 Preset Programs
<b>Heart Rate</b>	• Hand Sensor Heart Rate Contacts, Compatible Wireless Heart Rate (Option)
<b>Electricity</b>	• 220V (50/60Hz) 10 AMP Dedicated Outlet
<b>Warranty</b>	• Warranty 2 yrs, Wear items 6 months, TV Panel 1 year
<b>Product Size</b>	• 2165 x 928 x 1645mm (LxWxH)
<b>Packing Size</b>	<ul style="list-style-type: none"> <li>• 2220 x 970 x 745 mm (LxWxH), 1.6 cbm,</li> <li>• Net Weight 200Kg, Gross Weight 220Kg</li> </ul>



# NR25XA



## KEY FEATURES

- **Smart Device Mirroring** Allows the exerciser to mirror their Smart device onto the 21.5 inch display screen. Supports both iOS and Android devices.
- **Floating Deck Technology** Patented system provides force reduction to the exerciser. (Patents No. 10-1371607)
- **Dual Incline System** Patented system reduces the load on the incline motor by at least 50 %. This drastically extends the life of the incline motor and lifting mechanism and provides a very quiet system without any rolling while running. (Patents No. 10-0624647)

<b>Speed</b>	• 0.8 ~ 25 kph (0.1 kph increments) 0.5 ~ 15.5 mph
<b>Incline</b>	• 0 ~ 16 % (0.1% increments) Dual Axle System
<b>Motor Duty</b>	• AC 5HP (Treadmill Duty)
<b>AC Motor Control</b>	• Fuji Inverter Control
<b>Roller Diameter</b>	• 100 mm / 4"
<b>Running Space</b>	• 1620 x x 520 mm (L x W) 64 inches x 20 inches
<b>Max. User Weight</b>	• 180 kg / 397 lbs
<b>Product Weight</b>	• 200 kg / 440 lbs
<b>Entertainment</b>	<ul style="list-style-type: none"> <li>• 21.5 inches Display Panel (HDTV Supported)</li> <li>• Touch Screen System with Android OS</li> <li>• Smartphone Display Mirroring to Monitor (Android &amp; iOS)</li> <li>• USB Charge port, Wired Headphone Jack, Bluetooth Connectivity (only for Wireless Headphone)</li> <li>• Virtual Street Views of 8 European Cities</li> </ul>
<b>Internet</b>	• Wired and Wireless Connectivity
<b>Console Display</b>	• Speed, Incline, Time, Distance, Calorie, Heart Rate
<b>Exercise Program</b>	• 12 Preset Programs
<b>Heart Rate</b>	• Hand Sensor Heart Rate Contacts, Compatible Wireless Heart Rate (Option)
<b>Electricity</b>	• 220V (50/60Hz) 10 AMP Dedicated Outlet
<b>Warranty</b>	• Warranty 2 yrs, Wear items 6 months, TV Panel 1 year
<b>Product Size</b>	• 2165 x 928 x 1645mm (LxWxH)
<b>Packing Size</b>	• 2220 x 970 x 745 mm (LxWxH), 1.6 cbm, • Net Weight 200Kg, Gross Weight 220Kg



# NR30XA



## KEY FEATURES

- **Smart Device Mirroring** Allows the exerciser to mirror their Smart device onto the 21.5 inch display screen. Supports both iOS and Android devices.
- **Floating Deck Technology** Patented system provides force reduction to the exerciser. (Patents No. 10-1371607)
- **Dual Incline System** Patented system reduces the load on the incline motor by at least 50 %. This drastically extends the life of the incline motor and lifting mechanism and provides a very quiet system without any rolling while running. (Patents No. 10-0624647)

<b>Speed</b>	• 0.8 ~ 25 kph (0.1 kph increments) 0.5 ~ 15.5 mph
<b>Incline</b>	• 0 ~ 22 % (0.1% increments) Dual Axle System
<b>Motor Duty</b>	• AC 5HP (Treadmill Duty)
<b>AC Motor Control</b>	• Fuji Inverter Control
<b>Roller Diameter</b>	• 100 mm / 4"
<b>Running Space</b>	• 1620 x x 520 mm (L x W) 64 inches x 20 inches
<b>Max. User Weight</b>	• 180 kg / 397 lbs
<b>Product Weight</b>	• 200 kg / 440 lbs
<b>Entertainment</b>	<ul style="list-style-type: none"> <li>• 21.5 inches Display Panel (HDTV Supported)</li> <li>• Touch Screen System with Android OS</li> <li>• Smartphone Display Mirroring to Monitor (Android &amp; iOS)</li> <li>• USB Charge port, Wired Headphone Jack, Bluetooth Connectivity (only for Wireless Headphone)</li> <li>• Virtual Street Views of 8 European Cities</li> </ul>
<b>Internet</b>	• Wired and Wireless Connectivity
<b>Console Display</b>	• Speed, Incline, Time, Distance, Calorie, Heart Rate
<b>Exercise Program</b>	• 12 Preset Programs
<b>Heart Rate</b>	• Hand Sensor Heart Rate Contacts, Compatible Wireless Heart Rate (Option)
<b>Electricity</b>	• 220V (50/60Hz) 10 AMP Dedicated Outlet
<b>Warranty</b>	• Warranty 2 yrs, Wear items 6 months, TV Panel 1 year
<b>Product Size</b>	• 2165 x 928 x 1645mm (LxWxH)
<b>Packing Size</b>	• 2220 x 970 x 745 mm (LxWxH), 1.6 cbm, • Net Weight 200Kg, Gross Weight 220Kg



# NR20SXA



## KEY FEATURES

- SpeedSync Auto Speed Control** Technology Patented system detects user position and automatically adjusts the treadmill speed without using buttons or the touch screen. As the exerciser moves forward the belt speeds up and as the user moves away from the console the belt speed is reduced. (Patents No. 10-0737394)
- Smart Device Mirroring** Allows the exerciser to mirror their Smart device onto the 21.5 inch display screen. Supports both iOS and Android devices.
- Floating Deck** Technology Patented system provides force reduction to the exerciser. (Patents No. 10-1371607)
- Dual Incline System** Patented system reduces the load on the incline motor by at least 50 %. This drastically extends the life of the incline motor and lifting mechanism and provides a very quiet system without any rolling while running. (Patents No. 10-0624647)

<b>Speed</b>	• 0.8 ~ 20 kph (0.1 kph increments) 0.5 ~ 12.5 mph
<b>Incline</b>	• 0 ~ 16 % (0.1% increments) Dual Axle System
<b>Motor Duty</b>	• AC 3HP (Treadmill Duty)
<b>AC Motor Control</b>	• Fuji Inverter Control
<b>Roller Diameter</b>	• 100 mm / 4"
<b>Running Space</b>	• 1620 x x 520 mm (L x W) 64 inches x 20 inches
<b>Max. User Weight</b>	• 180 kg / 397 lbs
<b>Product Weight</b>	• 200 kg / 440 lbs
<b>SPEED SYNC</b>	• Recognizes user position and adjusts speed automatically
<b>Entertainment</b>	• 21.5 inches Display Panel (HDTV Supported)
	• Touch Screen System with Android OS
	• Smartphone Display Mirroring to Monitor (Android & iOS)
	• USB Charge port, Wired Headphone Jack, Bluetooth Connectivity (only for Wireless Headphone)
<b>Internet</b>	• Virtual Street Views of 8 European Cities
	• Wired and Wireless Connectivity
<b>Console Display</b>	• Speed, Incline, Time, Distance, Calorie, Heart Rate
<b>Exercise Program</b>	• 12 Preset Programs
<b>Heart Rate</b>	• Hand Sensor Heart Rate Contacts, Compatible Wireless Heart Rate (Option)
<b>Electricity</b>	• 220V (50/60Hz) 10 AMP Dedicated Outlet
<b>Warranty</b>	• Warranty 2 yrs, Wear items 6 months, TV Panel 1 year
<b>Safety</b>	• Auto Sensor shuts off the treadmill when user is not detected
<b>Product Size</b>	• 2165 x 928 x 1645mm (LxWxH)
<b>Packing Size</b>	• 2220 x 970 x 745 mm (LxWxH), 1.6 cbm,
	• Net Weight 200Kg, Gross Weight 220Kg

# NR25SXA



## KEY FEATURES

- SpeedSync Auto Speed Control** Technology Patented system detects user position and automatically adjusts the treadmill speed without using buttons or the touch screen. As the exerciser moves forward the belt speeds up and as the user moves away from the console the belt speed is reduced. (Patents No. 10-0737394)
- Smart Device Mirroring** Allows the exerciser to mirror their Smart device onto the 21.5 inch display screen. Supports both iOS and Android devices.
- Floating Deck** Technology Patented system provides force reduction to the exerciser. (Patents No. 10-1371607)
- Dual Incline System** Patented system reduces the load on the incline motor by at least 50 %. This drastically extends the life of the incline motor and lifting mechanism and provides a very quiet system without any rolling while running. (Patents No. 10-0624647)

<b>Speed</b>	• 0.8 ~ 25 kph (0.1 kph increments) 0.5 ~ 15.5 mph
<b>Incline</b>	• 0 ~ 16 % (0.1% increments) Dual Axle System
<b>Motor Duty</b>	• AC 5HP (Treadmill Duty)
<b>AC Motor Control</b>	• Fuji Inverter Control
<b>Roller Diameter</b>	• 100 mm / 4"
<b>Running Space</b>	• 1620 x x 520 mm (L x W) 64 inches x 20 inches
<b>Max. User Weight</b>	• 180 kg / 397 lbs
<b>Product Weight</b>	• 200 kg / 440 lbs
<b>SPEED SYNC</b>	• Recognizes user position and adjusts speed automatically
<b>Entertainment</b>	• 21.5 inches Display Panel (HDTV Supported)
	• Touch Screen System with Android OS
	• Smartphone Display Mirroring to Monitor (Android & iOS)
	• USB Charge port, Wired Headphone Jack, Bluetooth Connectivity (only for Wireless Headphone)
<b>Internet</b>	• Virtual Street Views of 8 European Cities
	• Wired and Wireless Connectivity
<b>Console Display</b>	• Speed, Incline, Time, Distance, Calorie, Heart Rate
<b>Exercise Program</b>	• 12 Preset Programs
<b>Heart Rate</b>	• Hand Sensor Heart Rate Contacts, Compatible Wireless Heart Rate (Option)
<b>Electricity</b>	• 220V (50/60Hz) 10 AMP Dedicated Outlet
<b>Warranty</b>	• Warranty 2 yrs, Wear items 6 months, TV Panel 1 year
<b>Safety</b>	• Auto Sensor shuts off the treadmill when user is not detected
<b>Product Size</b>	• 2165 x 928 x 1645mm (LxWxH)
<b>Packing Size</b>	• 2220 x 970 x 745 mm (LxWxH), 1.6 cbm,
	• Net Weight 200Kg, Gross Weight 220Kg



# NR30SXA



## KEY FEATURES

- SpeedSync Auto Speed Control** Technology Patented system detects user position and automatically adjusts the treadmill speed without using buttons or the touch screen. As the exerciser moves forward the belt speeds up and as the user moves away from the console the belt speed is reduced. (Patents No. 10-0737394)
- Smart Device Mirroring** Allows the exerciser to mirror their Smart device onto the 21.5 inch display screen. Supports both iOS and Android devices.
- Floating Deck** Technology Patented system provides force reduction to the exerciser. (Patents No. 10-1371607)
- Dual Incline System** Patented system reduces the load on the incline motor by at least 50 %. This drastically extends the life of the incline motor and lifting mechanism and provides a very quiet system without any rolling while running. (Patents No. 10-0624647)

<b>Speed</b>	• 0.8 ~ 25 kph (0.1 kph increments) 0.5 ~ 15.5 mph
<b>Incline</b>	• 0 ~ 22 % (0.1% increments) Dual Axle System
<b>Motor Duty</b>	• AC 5HP (Treadmill Duty)
<b>AC Motor Control</b>	• Fuji Inverter Control
<b>Roller Diameter</b>	• 100 mm / 4"
<b>Running Space</b>	• 1620 x x 520 mm (L x W) 64 inches x 20 inches
<b>Max. User Weight</b>	• 180 kg / 397 lbs
<b>Product Weight</b>	• 200 kg / 440 lbs
<b>SPEED SYNC</b>	• Recognizes user position and adjusts speed automatically
<b>Entertainment</b>	• 21.5 inches Display Panel (HDTV Supported)
	• Touch Screen System with Android OS
	• Smartphone Display Mirroring to Monitor (Android & iOS)
	• USB Charge port, Wired Headphone Jack, Bluetooth Connectivity (only for Wireless Headphone)
<b>Internet</b>	• Virtual Street Views of 8 European Cities
	• Wired and Wireless Connectivity
<b>Console Display</b>	• Speed, Incline, Time, Distance, Calorie, Heart Rate
<b>Exercise Program</b>	• 12 Preset Programs
<b>Heart Rate</b>	• Hand Sensor Heart Rate Contacts, Compatible Wireless Heart Rate (Option)
<b>Electricity</b>	• 220V (50/60Hz) 10 AMP Dedicated Outlet
<b>Warranty</b>	• Warranty 2 yrs, Wear items 6 months, TV Panel 1 year
<b>Safety</b>	• Auto Sensor shuts off the treadmill when user is not detected
<b>Product Size</b>	• 2165 x 928 x 1645mm (LxWxH)
<b>Packing Size</b>	• 2220 x 970 x 745 mm (LxWxH), 1.6 cbm,
	• Net Weight 200Kg, Gross Weight 220Kg



## Console of NR Series (21.5" LCD Display)



Please note that most versions of AirServer(iPhone) do not support any DRM protected content. The AirServer Connect hardware has support for DRM protected content using cast from apps.

There are some limitations in that services offering DRM (Digital Rights Management) protected content. Certain streaming apps, such as but not limited to Netflix, Hulu, Apple TV+, Disney+, Amazon Prime Video, HBO Max, and most sports/TV apps, either use their custom protocol or prevent connections that are not originating from the sending device.

This a limitation set by the content providers. Unfortunately, this is not something within our control. We are looking into ways of implementing support for this in future versions of AirServer, but in the meantime, you should be able to stream content over mirroring in some cases.

<https://support.airserver.com/support/solutions/articles/43000512407-some-streaming-apps-such-as-netflix-hulu-apple-tv-disney-hbo-do-not-work-with-airserver>

대부분의 AirServer (아이폰 화면공유 프로그램) 버전은 DRM 보호 콘텐츠를 지원하지 않습니다. AirServer Connect 하드웨어는 앱에서 캐스트방식으로 DRM 보호 콘텐츠를 지원합니다. DRM(Digital Rights Management) 보호 콘텐츠를 제공하는 서비스들은 일부 제한이 있습니다. Netflix, Hulu, Apple TV+, Disney+, Amazon Prime Video, HBO Max 및 많은 스포츠/TV 앱들과 같은 특정 스트리밍 앱들은 자체 프로토콜을 사용하거나 또는 외부 장치에서 생성되지 않은 연결을 제한합니다. 이 제한은 콘텐츠 제공자에 의해 설정되었으므로 우리가 통제할 수 없습니다. 향후의 AirServer버전으로 이 지원을 구현할 수 있는 방법을 모색하겠지만, 그때까지는 일부 콘텐츠에 한해 미러링 연결이 가능할 것입니다.



# My Mountain



## KEY FEATURES

- **Mountain Climbing** : Walk at up to a 50% incline for hiking and climbing simulation. Burn up 1.5 times more calories walking at mid to high incline compared to running on a flat surface. Low impact, high intensity exercise.
- **-5 ~ 50% Incline** : -5% decline for rehabilitation to 50% incline for high intensity training makes MyMountain a very diverse machine.
- **Minimal Floor Space** : Compact footprint saves floor space. 42" long and 20" wide total size.
- **Walking Only** : Can be used as a walking machine for athletes and older adults.

<b>Speed</b>	• 0.3 ~ 8 kph (0.1 kph increments) 0.18 ~ 5 mph
<b>Incline</b>	• -5 ~ 50 % (1% resolution)
<b>Motor Duty</b>	• AC 2 HP (continuous duty)
<b>AC Motor Control</b>	• Fuji Inverter Control
<b>Roller Diameter</b>	• 75 mm / 2.95"
<b>Running Space</b>	• 1070 x 510 mm (LxW) 42.1 x 20 inches
<b>Max. User Weight</b>	• 130 kg / 286.6 lbs
<b>Product Weight</b>	• 135 kg / 297.6 lbs
<b>Display</b>	• 3 color Dot Matrix
<b>Console Display</b>	• Speed, Incline, Time, Distance, Calorie, Heart Rate
<b>Exercise Program</b>	• 12 Preset Program,
<b>Electricity</b>	• 220V, 50/60Hz
<b>Warranty</b>	• 2 years. Running Belt 6 months
<b>Product Size</b>	• 1245 x 1049 x 1629 mm (LxWxH)
<b>Packing Size</b>	• 1100 x 1200 x 650 mm (LxWxH), 0.85 cbm, • Net Weight 135Kg, Gross Weight 145Kg



# My Mountain



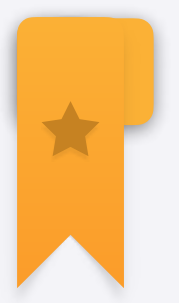

# DRAXFIT+



## KEY FEATURES

- Walking or HIIT Training :** It can change speeds faster than a motorized treadmill. Exerciser self regulates the speed by their stride and effort.
- Zero Electrical Costs :** User powered machine is portable with integrated move bar and wheels for use inside or outside the gym.
- Burn More Calories :** The Journal of Science and Medicine in Sport published a study in 2018 showing that self powered treadmills can burn up to 30% more calories than motor driven treadmills.
- Comfortable Curved Running Surface :** The rubberized surface slat design reduces impact on the joints. The curve of the surface promote a forefoot strike instead of a heel strike for better running form.

<b>Speed</b>	• Self Powered
<b>Roller Diameter</b>	• 175 mm / 6.88"
<b>Running Space</b>	• 1640 x 430mm (LxW) 64.5" L x 16.9" W
<b>Max. User Weight</b>	• 180 kg / 397 lbs
<b>Product Weight</b>	• 125 kg / 275.6 lbs
<b>Console Display</b>	• Speed, Time, Distance, Calorie, Heart Rate
<b>Warranty</b>	• 2 years
<b>Product Size</b>	• 1825 x 784 x 1608 mm (LxWxH)
<b>Packing Size</b>	• 1880 x 820 x 560 mm (LxWxH), 0.94 cbm, • Net Weight 125Kg, Gross Weight 135Kg



# DRAXFIT+





## DE6



### KEY FEATURES

- Low 7" step up height for easy accessibility
- Oversized foot plates with narrow spacing to ensure a comfortable workout
- Movement arms and stationary bars for total body or lower body only workouts
- Accessory Tray & Bottle Holder
- Transportation Wheels

<b>Exercise Level</b>	• 25 Exercise Level
<b>Drive System</b>	• Hybrid Generator System
<b>Max. User Weight</b>	• 180 kg / 397 lbs
<b>Product Weight</b>	• 120 kg / 264 lbs
<b>Stride Length</b>	• 510 mm / 20"
<b>Display</b>	• DOT MATRIX
<b>Console Display</b>	• Time, Distance, Calorie, Heart Rate
<b>Heart Rate</b>	• Polar Compatible Wireless Heart Rate, Hand Sensor Heart Rate Contacts
<b>Electricity</b>	• Self generating power
<b>Warranty</b>	• Warranty 2 yrs, Wear items 6 months
<b>Product Size</b>	• 2120 x 610 x 1730 mm (LxWxH)
<b>Packing Size</b>	• 2240 x 1110 x 690 mm (LxWxH), 1.65 cbm, • Net Weight 120Kg, Gross Weight 130Kg



## DE6X



### KEY FEATURES

- Smart Device Mirroring Allows the exerciser to mirror their Smart device onto the 15.6 inch display screen.
- Low 7" step up height for easy accessibility
- Oversized foot plates with narrow spacing to ensure a comfortable workout
- Movement arms and stationary bars for total body or lower body only workouts
- Accessory Tray & Bottle Holder
- Transportation Wheels

<b>Exercise Level</b>	• 25 Exercise Level
<b>Drive System</b>	• Hybrid Generator System
<b>Max. User Weight</b>	• 180 kg / 397 lbs
<b>Product Weight</b>	• 120 kg / 264 lbs
<b>Stride Length</b>	• 510 mm / 20"
<b>Display</b>	• 15.6 inches LCD Screen
<b>Console Display</b>	• Time, Distance, Calorie, Heart Rate
<b>Heart Rate</b>	• Polar Compatible Wireless Heart Rate, Hand Sensor Heart Rate Contacts
<b>Electricity</b>	• 220V, 50/60Hz (LCD display)
<b>Warranty</b>	• Warranty 2 yrs, Wear items 6 months, TV Panel 1 year
<b>Product Size</b>	• 2120 x 610 x 1730 mm (LxWxH)
<b>Packing Size</b>	• 2240 x 1110 x 690 mm (LxWxH), 1.65 cbm, • Net Weight 120Kg, Gross Weight 130Kg



## DE6A



### KEY FEATURES

- Smart Device Mirroring Allows the exerciser to mirror their Smart device onto the 15.6 inch display screen. Supports both iOS and Android devices.
- Low 7" step up height for easy accessibility
- Oversized foot plates with narrow spacing to ensure a comfortable workout
- Movement arms and stationary bars for total body or lower body only workouts
- Accessory Tray & Bottle Holder
- Transportation Wheels

<b>Exercise Level</b>	• 25 Exercise Level
<b>Drive System</b>	• Hybrid Generator System
<b>Max. User Weight</b>	• 180 kg / 397 lbs
<b>Product Weight</b>	• 120 kg / 264 lbs
<b>Stride Length</b>	• 510 mm / 20"
<b>Display</b>	• 15.6 inches LCD Screen
<b>Touch</b>	• Touch Screen (Capacitive type)
<b>Console Display</b>	• Time, Distance, Calorie, Heart Rate
<b>Heart Rate</b>	• Polar Compatible Wireless Heart Rate, Hand Sensor Heart Rate Contacts
<b>Electricity</b>	• 220V, 50/60Hz (LCD display)
<b>Warranty</b>	• Warranty 2 yrs, Wear items 6 months, TV Panel 1 year
<b>Product Size</b>	• 2120 x 610 x 1730 mm (LxWxH)
<b>Packing Size</b>	• 2240 x 1110 x 690 mm (LxWxH), 1.65 cbm, • Net Weight 120Kg, Gross Weight 130Kg

# TBR9000



## KEY FEATURES

- Easy Access: Step through design and handlebar for easy access
- Quick Controls: Quick change levels on handlebar
- Comfort: Contoured seat and back pad for comfortable ride
- Accessory Tray & Bottle Holder

<b>Exercise Level</b>	• 25 Exercise Level
<b>Drive System</b>	• Hybrid Generator System
<b>Max. User Weight</b>	• 150 kg / 330 lbs
<b>Product Weight</b>	• 70 kg / 154 lbs
<b>Display</b>	• DOT MATRIX
<b>Console Display</b>	• Time, Distance, Calorie, Heart Rate
<b>Heart Rate</b>	• Polar Compatible Wireless Heart Rate, Hand Sensor Heart Rate Contacts
<b>Electricity</b>	• Self generating power
<b>Warranty</b>	• Warranty 2 yrs, Wear items 6 months
<b>Product Size</b>	• 1695 x 590 x 1396 mm (LxWxH)
<b>Packing Size</b>	• 1730 x 610 x 845 mm (LxWxH), 0.89 cbm, • Net Weight 70Kg, Gross Weight 80Kg





## DX6R



### KEY FEATURES

- Smart Device Mirroring Allows the exerciser to mirror their Smart device onto the 15.6 inch display screen.
- Easy Access: Step through design and handlebar for easy access
- Quick Controls: Quick change levels on handlebar
- Comfort: Contoured seat and back pad for comfortable ride
- Accessory Tray & Bottle Holder

<b>Exercise Level</b>	• 25 Exercise Level
<b>Drive System</b>	• Hybrid Generator System
<b>Max. User Weight</b>	• 150 kg / 330 lbs
<b>Product Weight</b>	• 70 kg / 154 lbs
<b>Display</b>	• 15.6 inches LCD Screen
<b>Console Display</b>	• Time, Distance, Calorie, Heart Rate
<b>Heart Rate</b>	• Polar Compatible Wireless Heart Rate, Hand Sensor Heart Rate Contacts
<b>Electricity</b>	• 220V, 50/60Hz (LCD display)
<b>Warranty</b>	• Warranty 2 yrs, Wear items 6 months, TV Panel 1 year
<b>Product Size</b>	• 1695 x 590 x 1396 mm (LxWxH)
<b>Packing Size</b>	• 1730 x 610 x 845 mm (LxWxH), 0.89 cbm, • Net Weight 70Kg, Gross Weight 80Kg



## DA6R



### KEY FEATURES

- Smart Device Mirroring Allows the exerciser to mirror their Smart device onto the 15.6 inch display screen. Supports both iOS and Android devices.
- Easy Access: Step through design and handlebar for easy access
- Quick Controls: Quick change levels on handlebar
- Comfort: Contoured seat and back pad for comfortable ride
- Accessory Tray & Bottle Holder

<b>Exercise Level</b>	• 25 Exercise Level
<b>Drive System</b>	• Hybrid Generator System
<b>Max. User Weight</b>	• 150 kg / 330 lbs
<b>Product Weight</b>	• 70 kg / 154 lbs
<b>Display</b>	• 15.6 inches LCD Screen
<b>Touch</b>	• Touch Screen (Capacitive type)
<b>Console Display</b>	• Time, Distance, Calorie, Heart Rate
<b>Heart Rate</b>	• Polar Compatible Wireless Heart Rate, Hand Sensor Heart Rate Contacts
<b>Electricity</b>	• 220V, 50/60Hz (LCD display)
<b>Warranty</b>	• Warranty 2 yrs, Wear items 6 months, TV Panel 1 year
<b>Product Size</b>	• 1695 x 590 x 1396 mm (LxWxH)
<b>Packing Size</b>	• 1730 x 610 x 845 mm (LxWxH), 0.89 cbm, • Net Weight 70Kg, Gross Weight 80Kg



## TBU9000



### KEY FEATURES

- Easy Access: Step through design and handlebar for easy access
- Quick Controls: Quick change levels on handlebar
- Comfort: Contoured seat for comfortable ride
- Accessory Tray & Bottle Holder

<b>Exercise Level</b>	• 25 Exercise Level
<b>Drive System</b>	• Hybrid Generator System
<b>Max. User Weight</b>	• 150 kg / 330 lbs
<b>Product Weight</b>	• 60 kg / 132 lbs
<b>Display</b>	• DOT MATRIX
<b>Console Display</b>	• Time, Distance, Calorie, Heart Rate
<b>Heart Rate</b>	• Polar Compatible Wireless Heart Rate, Hand Sensor Heart Rate Contacts
<b>Electricity</b>	• Self generating power
<b>Warranty</b>	• Warranty 2 yrs, Wear items 6 months
<b>Product Size</b>	• 1132 x 639 x 1521 mm (LxWxH)
<b>Packing Size</b>	• 1150 x 610 x 1015 mm (LxWxH), 0.89 cbm, • Net Weight 60Kg, Gross Weight 70Kg



## DX6U



### KEY FEATURES

- Smart Device Mirroring Allows the exerciser to mirror their Smart device onto the 15.6 inch display screen.
- Easy Access: Step through design and handlebar for easy access
- Quick Controls: Quick change levels on handlebar
- Comfort: Contoured seat for comfortable ride
- Accessory Tray & Bottle Holder

<b>Exercise Level</b>	• 25 Exercise Level
<b>Drive System</b>	• Hybrid Generator System
<b>Max. User Weight</b>	• 150 kg / 330 lbs
<b>Product Weight</b>	• 60 kg / 132 lbs
<b>Display</b>	• 15.6 inches LCD Screen
<b>Console Display</b>	• Time, Distance, Calorie, Heart Rate
<b>Heart Rate</b>	• Polar Compatible Wireless Heart Rate, Hand Sensor Heart Rate Contacts
<b>Electricity</b>	• 220V, 50/60Hz (LCD display)
<b>Warranty</b>	• Warranty 2 yrs, Wear items 6 months, TV Panel 1 year
<b>Product Size</b>	• 1132 x 639 x 1521 mm (LxWxH)
<b>Packing Size</b>	• 1150 x 610 x 1015 mm (LxWxH), 0.89 cbm, • Net Weight 60Kg, Gross Weight 70Kg



## DA6U



### KEY FEATURES

- Smart Device Mirroring Allows the exerciser to mirror their Smart device onto the 15.6 inch display screen. Supports both iOS and Android devices.
- Easy Access: Step through design and handlebar for easy access
- Quick Controls: Quick change levels on handlebar
- Comfort: Contoured seat for comfortable ride
- Accessory Tray & Bottle Holder

<b>Exercise Level</b>	• 25 Exercise Level
<b>Drive System</b>	• Hybrid Generator System
<b>Max. User Weight</b>	• 150 kg / 330 lbs
<b>Product Weight</b>	• 60 kg / 132 lbs
<b>Display</b>	• 15.6 inches LCD Screen
<b>Touch</b>	• Touch Screen (Capacitive type)
<b>Console Display</b>	• Time, Distance, Calorie, Heart Rate
<b>Heart Rate</b>	• Polar Compatible Wireless Heart Rate, Hand Sensor Heart Rate Contacts
<b>Electricity</b>	• 220V, 50/60Hz (LCD display)
<b>Warranty</b>	• Warranty 2 yrs, Wear items 6 months, TV Panel 1 year
<b>Product Size</b>	• 1132 x 639 x 1521 mm (LxWxH)
<b>Packing Size</b>	• 1150 x 610 x 1015 mm (LxWxH), 0.89 cbm, • Net Weight 60Kg, Gross Weight 70Kg



# DSC6 DRAX Stair Climber



<b>Exercise Level</b>	• 25 Exercise Level
<b>Drive System</b>	• EMB Sync Drive System Electromagnetic brake with combined chain-belt synchronized transmission driving system
<b>Max. User Weight</b>	• 180 kg / 397 lbs
<b>Product Weight</b>	• 146 kg / 320 lbs
<b>Display</b>	• LED
<b>Console Display</b>	• Time, Distance, Calorie, Heart Rate
<b>Heart Rate</b>	• Polar Compatible Wireless Heart Rate, Hand Sensor Heart Rate Contacts
<b>Electricity</b>	• 220V, 50/60Hz
<b>Warranty</b>	• Warranty 2 yrs, Wear items 6 months
<b>Step Size</b>	• Horizon : 301x457, Vertical : 226x457
<b>Product Size</b>	• 830 x 1594 x 2090 mm (LxWxH)
<b>Packing Size</b>	• 1035 x 1507 x 1350 mm (LxWxH), 1.74 cbm, • Net Weight 135Kg, Gross Weight 145Kg



# DSC6X DRAX Stair Climber



<b>Exercise Level</b>	• 25 Exercise Level
<b>Drive System</b>	• EMB Sync Drive System Electromagnetic brake with combined chain-belt synchronized transmission driving system
<b>Max. User Weight</b>	• 180 kg / 397 lbs
<b>Product Weight</b>	• 146 kg / 320 lbs
<b>Display</b>	• 15.6 inches LCD Screen
<b>Entertainment</b>	• Digital TV Tuner
<b>Console Display</b>	• Time, Distance, Calorie, Heart Rate
<b>Heart Rate</b>	• Polar Compatible Wireless Heart Rate, Hand Sensor Heart Rate Contacts
<b>Electricity</b>	• 220V, 50/60Hz (LCD display)
<b>Warranty</b>	• Warranty 2 yrs, Wear items 6 months, TV Panel 1 year
<b>Step Size</b>	• Horizon : 301x457, Vertical : 226x457
<b>Product Size</b>	• 830 x 1594 x 2090 mm (LxWxH)
<b>Packing Size</b>	• 1035 x 1507 x 1350 mm (LxWxH), 1.74 cbm, • Net Weight 135Kg, Gross Weight 145Kg



# DSC6A DRAX Stair Climber



<b>Exercise Level</b>	• 25 Exercise Level
<b>Drive System</b>	• EMB Sync Drive System Electromagnetic brake with combined chain-belt synchronized transmission driving system
<b>Max. User Weight</b>	• 180 kg / 397 lbs
<b>Product Weight</b>	• 146 kg / 320 lbs
<b>Display</b>	• DOT MATRIX
<b>Console Display</b>	• Time, Distance, Calorie, Heart Rate
<b>Heart Rate</b>	• Polar Compatible Wireless Heart Rate, Hand Sensor Heart Rate Contacts
<b>Electricity</b>	• 220V, 50/60Hz
<b>Warranty</b>	• Warranty 2 yrs, Wear items 6 months
<b>Step Size</b>	• Horizon : 301x457, Vertical : 226x457
<b>Product Size</b>	• 830 x 1594 x 2090 mm (LxWxH)
<b>Packing Size</b>	• 1035 x 1507 x 1350 mm (LxWxH), 1.74 cbm, • Net Weight 135Kg, Gross Weight 145Kg





# Console of Elliptical / Bikes / StairClimber (15.6" LCD Display)

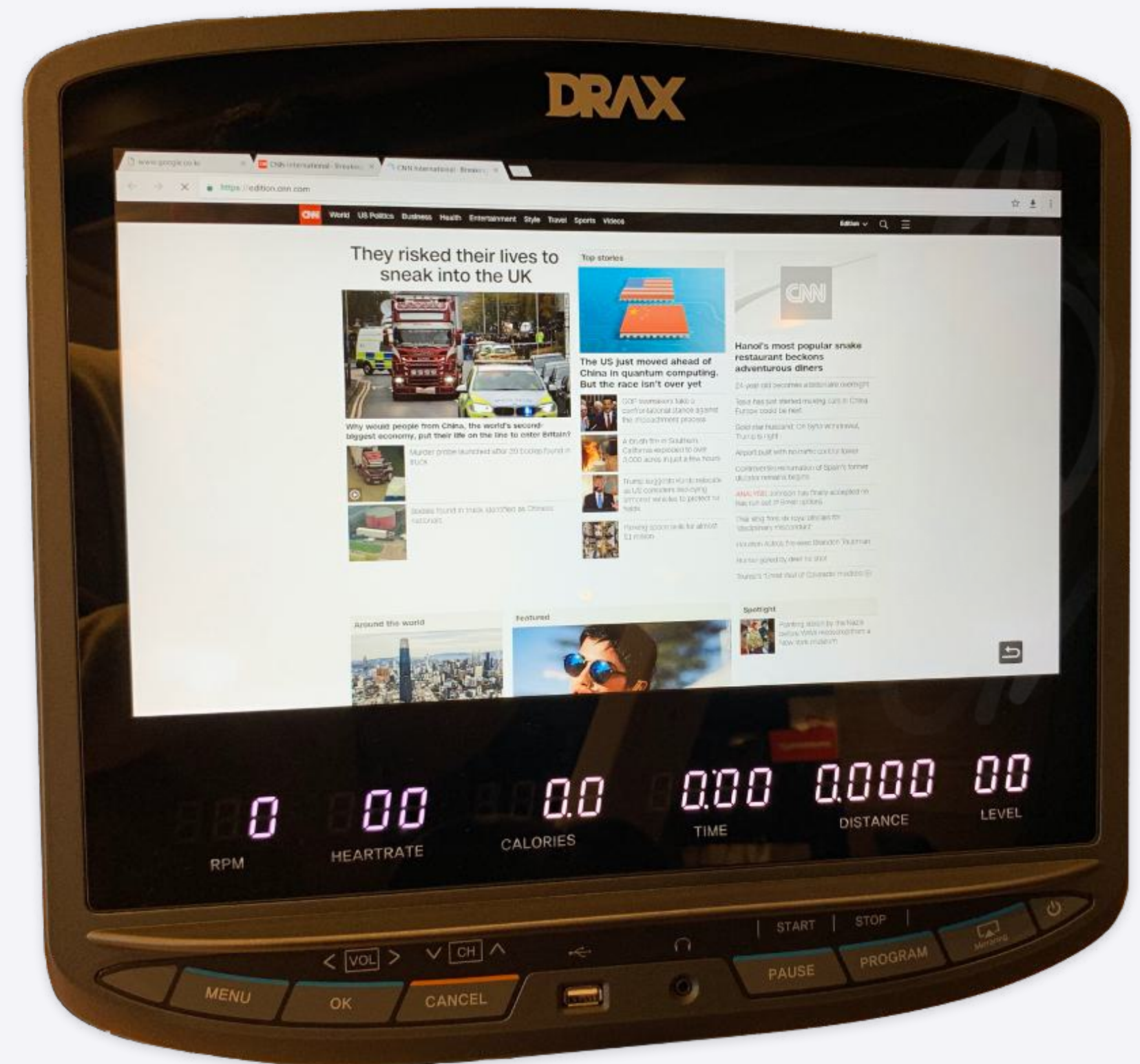



# GoFlex Multi-Stretching Machine



## KEY FEATURES

- Multi-functional for stretching specific areas of the body onto the 21.5 inch display screen.
- Excellent for injury recovery and pain management
- Equipped with 100 kinds of stretching exercise instructional video
- Efficient space organization
- Scientific design

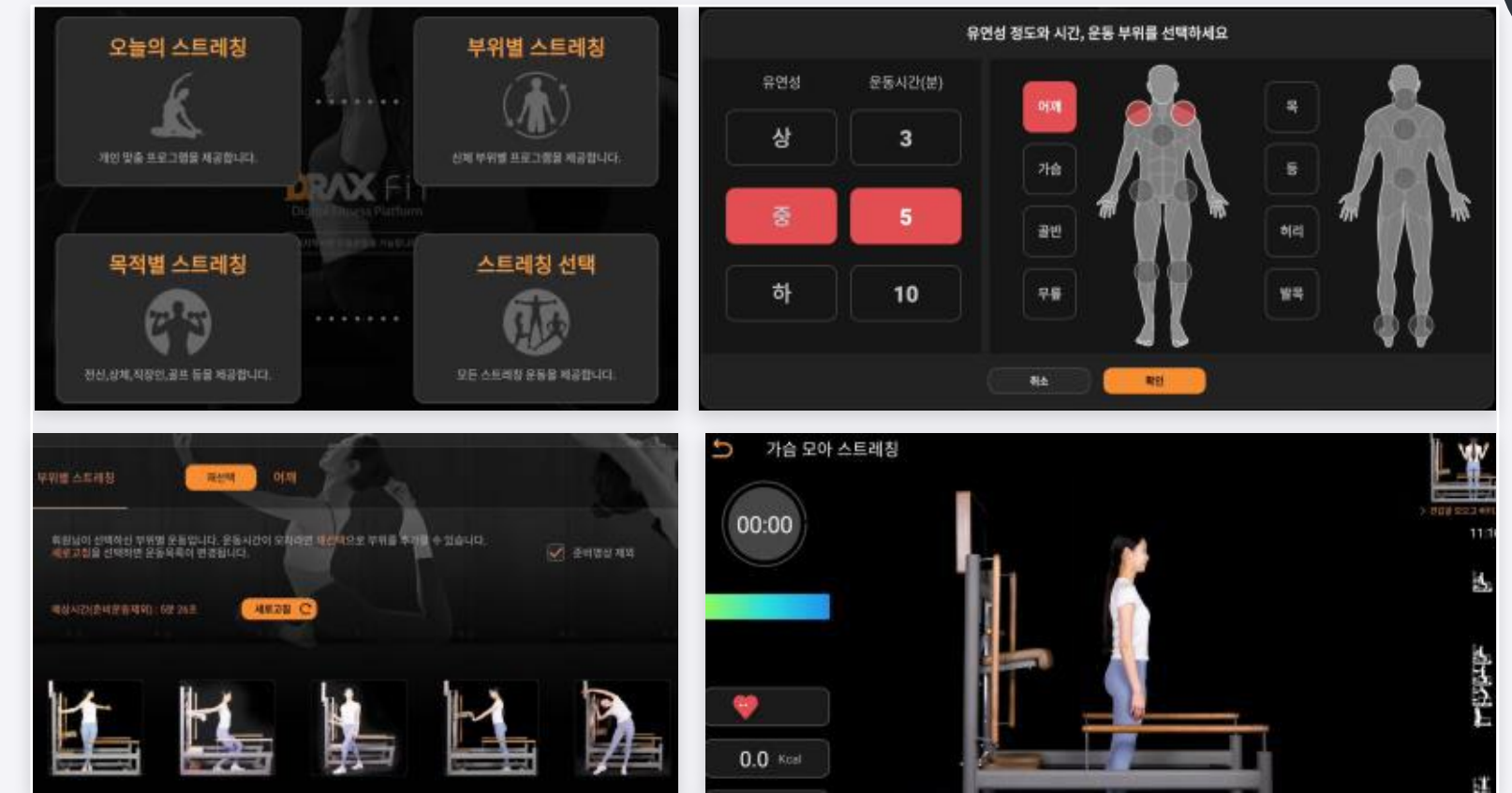

<b>Display</b>	• 21.5 inches Full HD LCD Touch Screen
<b>OS Sysmte</b>	• Android OS System
<b>Product Weight</b>	• 146 kg / 320 lbs
<b>Program</b>	• 100 Stretching Exercise
<b>Electricity</b>	• DC 12V
<b>Warranty</b>	• Warranty 1 yr
<b>Product Size</b>	• 1659 x 870 x 1650 mm (LxWxH)
<b>Packing Size</b>	-

# POWER TOWER



## KEY FEATURES

- Total Body climbing machine with a patented Continuously Variable Transmission (CVT). Twist Grip resistance mechanism for quick changes. Smooth rope and chain drive system.
- Adjustable movement arms, stationary arms and foot plates for optimal fit and variety of exercises. Exercises range from climbing to pushdowns and deadlifts.
- Battery Powered Console with workout data. Transport Wheels. Requires no electricity and is portable.

<b>Exercise Level</b>	• CVT (Continuously Variable Transmission) with Twist Grip
<b>Drive System</b>	• Rope & Chain Hybrid System
<b>Max. User Weight</b>	• 395 lbs (180 kg)
<b>Product Weight</b>	• 465 lbs (210 kg)
<b>Between Steps</b>	• 10.0 inches (255 mm)
<b>Movement Variability</b>	• 25.8 inches (657 mm)
<b>Console Display</b>	• Time, Distance, Calorie, RPM
<b>Electricity</b>	• Self Powered
<b>Warranty</b>	• Warranty 2 yrs, Wear items 6 months
<b>Product Size</b>	• 50.1 x 34.4 x 93.3 inches (1285 x 874 x 2370 mm) (LxWxH)
<b>Packing</b>	• Full Assembly Packing

## Drax Strength Equipment – TWMA Series

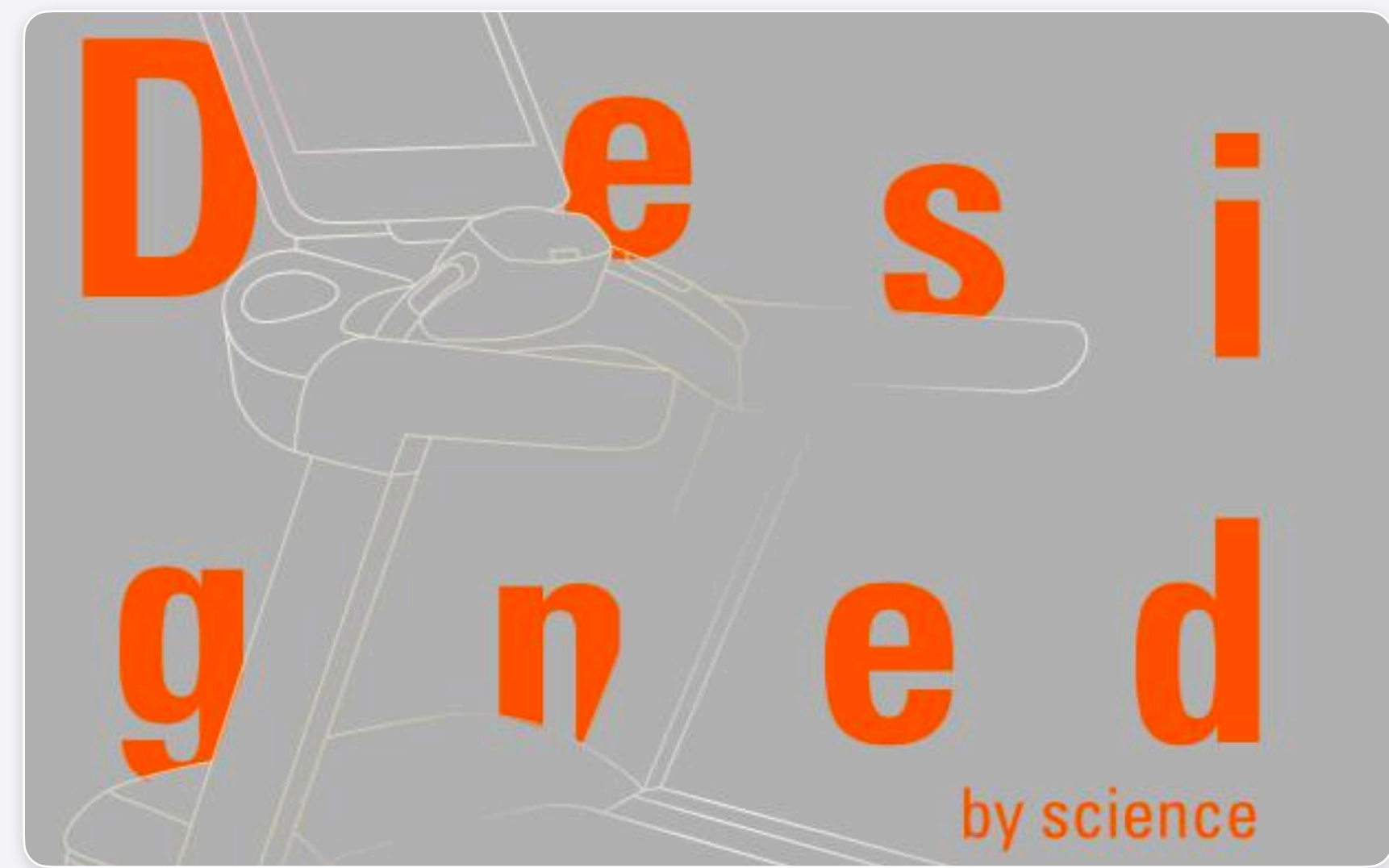
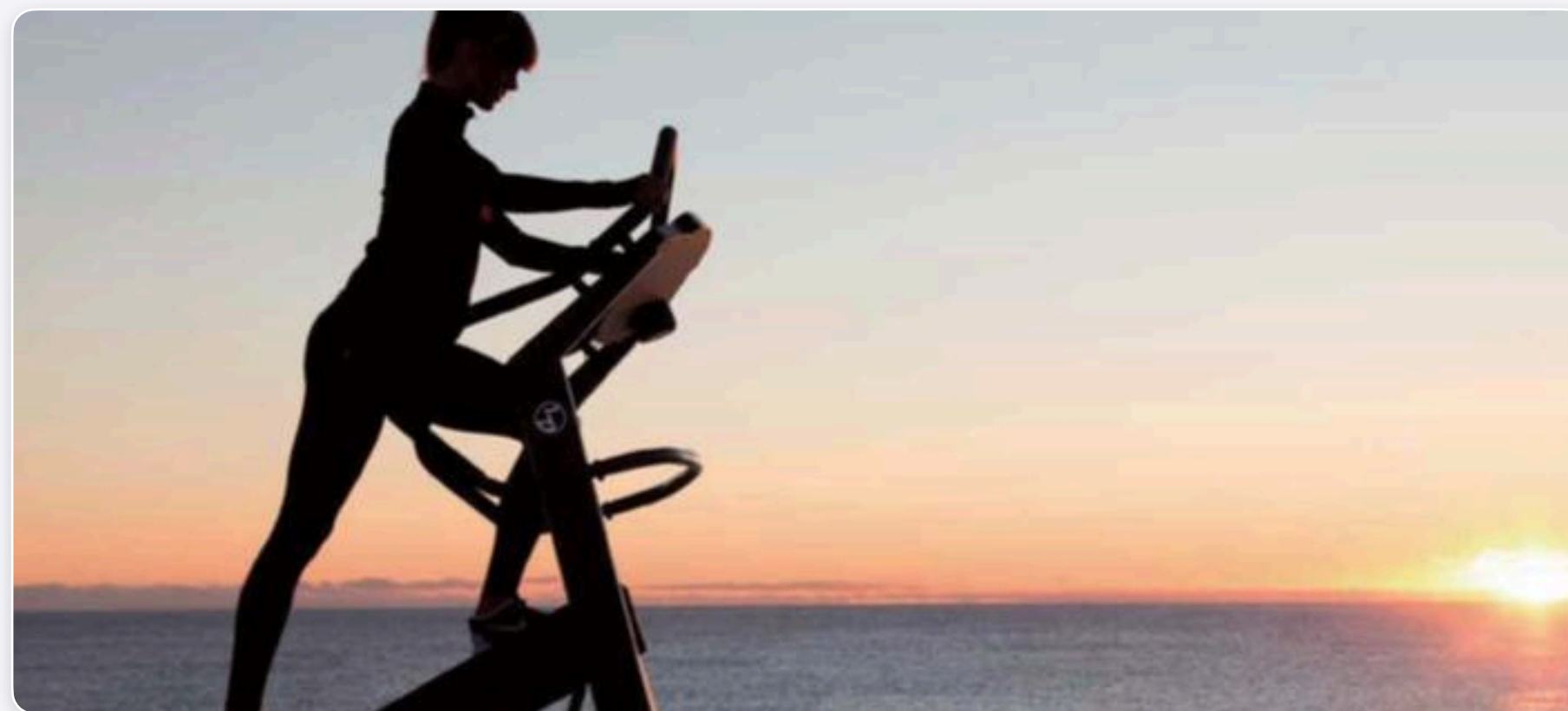

# TWMA 101 Seated Leg Press

## KEY FEATURES

- 2" x 4" Square Tubing 9 Gauge Steel
- Powder Coated Paint Finish with Clear Gloss Finish
- Solid Steel Weight Plates, Hard Chrome guides rods, Low Friction bushings
- Leg Press Seat Carriage roller wheels with sealed bearing glide on oversized guide rods
- Angled Seat Back reduces spine compression
- Textured oversized footplate for a variety of foot placements
- Full Weight Stack Shrouds
- Dimensions: 1170 x 1899 x 1747 mm (L x W x H) 74.7" L x 46" W x 68.7" H
- *Machine Weight : 210Kg / 463 lbs*
- *Standard Weight Stack : 140 kg / 308 lbs*



# TWMA 102 Leg Extension

## KEY FEATURES

- 2" x 4" Square Tubing 9 Gauge Steel
- Powder Coated Paint Finish with Clear Gloss Finish
- Solid Steel Weight Plates, Hard Chrome guides rods, Low Friction bushings
- 5 Start Range of Motion Adjustments
- All adjustments made from the user seated position
- Counterbalanced for lighter starting weight
- Full Weight Stack Shrouds
- Dimensions: 1055 x 1206 x 1542 mm (L x W x H) 41.5" L x 47.4" W x 60.7" H
- *Machine Weight : 200Kg / 441 lbs*
- *Standard Weight Stack : 100 kg / 220 lbs (Optional Max Stack Weight : 140 kg / 308 lbs)*





# TWMA 102-1 Leg Extension Adjustable

## KEY FEATURES

- 2" x 4" Square Tubing 9 Gauge Steel
- Powder Coated Paint Finish with Clear Gloss Finish
- Solid Steel Weight Plates, Hard Chrome guides rods, Low Friction bushings
- 5 Start Range of Motion Adjustments
- All adjustments made from the user seated position
- Counterbalanced for lighter starting weight
- Full Weight Stack Shrouds
- Adjustable Starting Position
- Dimensions: 1055 x 1206 x 1542 mm (L x W x H) 41.5" L x 47.4" W x 60.7" H
- *Machine Weight : 200Kg / 441 lbs*
- *Standard Weight Stack : 100 kg / 220 lbs (Optional Max Stack Weight : 140 kg / 308 lbs)*



# TWMA 103 Seated Leg Curl

## KEY FEATURES

- 2" x 4" Square Tubing 9 Gauge Steel
- Powder Coated Paint Finish with Clear Gloss Finish
- Solid Steel Weight Plates, Hard Chrome guides rods, Low Friction bushings
- 5 Start Range of Motion Adjustments
- All adjustments made from the user seated position
- Adjustable Thigh hold down pad
- Full Weight Stack Shrouds
- Dimensions: 1051 x 1209 x 1552 mm (L x W x H) 41.3" L x 47.5" W x 61.1" H
- *Machine Weight : 200Kg / 441 lbs*
- *Standard Weight Stack : 100 kg / 220 lbs (Optional Max Stack Weight : 140 kg / 308 lbs)*





## TWMA 103-1 Lying Leg Curl

### KEY FEATURES

- 2" x 4" Square Tubing 9 Gauge Steel
- Powder Coated Paint Finish with Clear Gloss Finish
- Solid Steel Weight Plates, Hard Chrome guides rods, Low Friction bushings
- Adjustable Ankle Pad
- Angled Pad design isolates Hamstrings and reduces Lower Back stress
- Full Weight Stack Shrouds
- Dimensions: 980 x 1653 x 1552 mm (L x W x H) 38.5" L x 65" W x 61.1" H
- *Machine Weight : 200Kg / 441 lbs*
- *Standard Weight Stack : 100 kg / 220 lbs (Optional Max Stack Weight : 140 kg / 308 lbs)*



# TWMA 103-2 Seated Leg Curl Adjustable

## KEY FEATURES

- 2" x 4" Square Tubing 9 Gauge Steel
- Powder Coated Paint Finish with Clear Gloss Finish
- Solid Steel Weight Plates, Hard Chrome guides rods, Low Friction bushings
- 5 Start Range of Motion Adjustments
- All adjustments made from the user seated position
- Adjustable Thigh hold down pad
- Full Weight Stack Shrouds
- Adjustable Starting Position
- Dimensions: 1051 x 1209 x 1552 mm (L x W x H) 41.3" L x 47.5" W x 61.1" H
- *Machine Weight : 200Kg / 441 lbs*
- *Standard Weight Stack : 100 kg / 220 lbs (Optional Max Stack Weight : 140 kg / 308 lbs)*



# TWMA 104 Hip Adductor

## KEY FEATURES

- 2" x 4" Square Tubing 9 Gauge Steel
- Powder Coated Paint Finish with Clear Gloss Finish
- Solid Steel Weight Plates, Hard Chrome guides rods, Low Friction bushings
- Comfortable Knee Pads & Foot Position
- 13 Start Range Adjustments made from the user position
- Front weight stack design for easy weight adjustment and privacy
- Full Weight Stack Shrouds
- Dimensions: 696 x 1542 x 1552 mm (L x W x H) 27.4" L x 60.7" W x 61.1" H
- *Machine Weight : 200Kg / 441 lbs*
- *Standard Weight Stack : 100 kg / 220 lbs (Optional Max Stack Weight : 140 kg / 308 lbs)*





## TWMA 105 Rotary Hip & Glute

### KEY FEATURES

- 2" x 4" Square Tubing 9 Gauge Steel
- Powder Coated Paint Finish with Clear Gloss Finish
- Solid Steel Weight Plates, Hard Chrome guides rods, Low Friction bushings
- Adjustable platform and roller pad for proper alignment
- Start range of motion for all movements
- Design allows four key user positions for lateral, anterior and posterior exercises
- Full Weight Stack Shrouds
- Dimensions: 961 x 1610 x 1792 mm (L x W x H) 37.8" L x 63.3" W x 70.5" H
- *Machine Weight : 260Kg / 573 lbs*
- *Standard Weight Stack : 100 kg / 220 lbs (Optional Max Stack Weight : 140 kg / 308 lbs)*



# TWMA 107 Hip Abductor

## KEY FEATURES

- 2" x 4" Square Tubing 9 Gauge Steel
- Powder Coated Paint Finish with Clear Gloss Finish
- Solid Steel Weight Plates, Hard Chrome guides rods, Low Friction bushings
- Comfortable Knee Pads & Foot Position
- 13 Start Range Adjustments made from the user position
- Front weight stack design for easy weight adjustment and privacy
- Full Weight Stack Shrouds
- Dimensions: 696 x 1524 x 1542 mm (L x W x H) 27.4" L x 60" W x 60.7" H
- *Machine Weight : 200Kg / 441 lbs*
- *Standard Weight Stack : 100 kg / 220 lbs (Optional Max Stack Weight : 140 kg / 308 lbs)*



# TWMA 108 Squat - Calf **DUAL**

## KEY FEATURES

- 2" x 4" Square Tubing 9 Gauge Steel
- Powder Coated Paint Finish with Clear Gloss Finish
- Solid Steel Weight Plates, Hard Chrome guides rods, Low Friction bushings
- Comfortable Shoulder Pads & Foot Position
- Front weight stack design for easy weight adjustment and privacy
- Full Weight Stack Shrouds
- Dimensions: 1153 x 1152 x 1576 mm (L x W x H) 45.4" L x 45.3" W x 62.0" H
- *Machine Weight : 90Kg / 198 lbs*
- *Standard Weight Stack : 100 kg / 220 lbs (Optional Max Stack Weight : 140 kg / 308 lbs)*



# TWMA 109 Hip Adductor-Abductor **DUAL**

## KEY FEATURES

- 2" x 4" Square Tubing 9 Gauge Steel
- Powder Coated Paint Finish with Clear Gloss Finish
- Solid Steel Weight Plates, Hard Chrome guides rods, Low Friction bushings
- Comfortable Knee Pads & Foot Position
- 13 Start Range Adjustments made from the user position
- Front weight stack design for easy weight adjustment and privacy
- Full Weight Stack Shrouds
- Dimensions: 696 x 1454 x 1555 mm (L x W x H) 27.4" L x 57.2" W x 61.2" H
- *Machine Weight : 200Kg / 441 lbs*
- *Standard Weight Stack : 100 kg / 220 lbs (Optional Max Stack Weight : 140 kg / 308 lbs)*





# TWMA 131 Leg Extension - Leg Curl **DUAL**

## KEY FEATURES

- 2" x 4" Square Tubing 9 Gauge Steel
- Powder Coated Paint Finish with Clear Gloss Finish
- Solid Steel Weight Plates, Hard Chrome guides rods, Low Friction bushings
- 5 Start Range of Motion Adjustments
- All adjustments made from the user seated position
- Counterbalanced for lighter starting weight
- Full Weight Stack Shrouds
- Dimensions: 1076 x 1206 x 1552 mm (L x W x H) 42.3" L x 47.4" W x 61.1" H
- *Machine Weight : 142Kg / 313 lbs*
- *Standard Weight Stack : 100 kg / 220 lbs (Optional Max Stack Weight : 140 kg / 308 lbs)*







# TWMA 201 Abdominal Crunch

## KEY FEATURES

- 2" x 4" Square Tubing 9 Gauge Steel
- Powder Coated Paint Finish with Clear Gloss Finish
- Solid Steel Weight Plates, Hard Chrome guides rods, Low Friction bushings
- Counterbalanced for lighter starting weight
- Three foot positions increase difficulty and isolate different muscles
- Full Weight Stack Shrouds
- Dimensions: 922 x 1565 x 1552 mm (L x W x H) 36.2" L x 61.6" W x 61.1" H
- *Machine Weight : 190Kg / 419 lbs*
- *Standard Weight Stack : 100 kg / 220 lbs (Optional Max Stack Weight : 140 kg / 308 lbs)*



## TWMA 202 Back Extension

### KEY FEATURES

- 2" x 4" Square Tubing 9 Gauge Steel
- Powder Coated Paint Finish with Clear Gloss Finish
- Solid Steel Weight Plates, Hard Chrome guides rods, Low Friction bushings
- Adjustable starting position changes range of motion
- Three foot positions for proper fit for users height
- Angled design and lumbar roller pad for proper fit and eliminates the need for a hold down device
- Full Weight Stack Shrouds
- Dimensions: 962 x 1247 x 1565 mm (L x W x H) 37.8" L x 49" W x 61.6" H
- *Machine Weight : 190Kg / 419 lbs*
- *Standard Weight Stack : 100 kg / 220 lbs (Optional Max Stack Weight : 140 kg / 308 lbs)*



# TWMA 204 Rotary Torso

## KEY FEATURES

- 2" x 4" Square Tubing 9 Gauge Steel
- Powder Coated Paint Finish with Clear Gloss Finish
- Solid Steel Weight Plates, Hard Chrome guides rods, Low Friction bushings
- Adjustable starting positions changes range of motion
- Upper torso rotation while seat and knee pads stabilize the lower body
- Full Weight Stack Shrouds
- Dimensions: 1198 x 1009 x 1552 mm (L x W x H) 47.1" L x 39.7" W x 61.1" H
- *Machine Weight : 175Kg / 385 lbs*
- *Standard Weight Stack : 100 kg / 220 lbs (Optional Max Stack Weight : 140 kg / 308 lbs)*





## TWMA 231 Abdominal - Back Extension **DUAL**

### KEY FEATURES

- 2" x 4" Square Tubing 9 Gauge Steel
- Powder Coated Paint Finish with Clear Gloss Finish
- Solid Steel Weight Plates, Hard Chrome guides rods, Low Friction bushings
- Counterbalanced for lighter starting weight
- Three foot positions increase difficulty and isolate different muscles
- Full Weight Stack Shrouds
- Dimensions: 973 x 1297 x 1552 mm (L x W x H) 38.3" L x 51.0" W x 61.1" H
- *Machine Weight : 127Kg / 280 lbs*
- *Standard Weight Stack : 100 kg / 220 lbs (Optional Max Stack Weight : 140 kg / 308 lbs)*



# TWMA 301 Chest Press

## KEY FEATURES

- 2" x 4" Square Tubing 9 Gauge Steel
- Powder Coated Paint Finish with Clear Gloss Finish
- Solid Steel Weight Plates, Hard Chrome guides rods, Low Friction bushings
- 5 Adjustable start positions
- Easy seat adjustment ratcheting system
- Easy entry design
- Full Weight Stack Shrouds
- Dimensions: 1531 x 1041 x 1552 mm (L x W x H) / 60.2" L x 40.9" W x 61.1" H
- *Machine Weight : 190Kg / 419 lbs*
- *Standard Weight Stack : 100 kg / 220 lbs (Optional Max Stack Weight : 140 kg / 308 lbs)*



# TWMA 302 Shoulder Press

## KEY FEATURES

- 2" x 4" Square Tubing 9 Gauge Steel
- Powder Coated Paint Finish with Clear Gloss Finish
- Solid Steel Weight Plates, Hard Chrome guides rods, Low Friction bushings
- Counterbalanced for lighter starting weight
- Horizontal & Neutral Grip positions
- Easy seat adjustment ratcheting system
- Easy entry design
- Full Weight Stack Shrouds
- Dimensions: 1406 x 1426 x 1552 mm (L x W x H) 55.3" L x 56.1" W x 61.1" H
- *Machine Weight : 190Kg / 419 lbs*
- *Standard Weight Stack : 100 kg / 220 lbs (Optional Max Stack Weight : 140 kg / 308 lbs)*



# TWMA 303 Low Cable Row

## KEY FEATURES

- 2" x 4" Square Tubing 9 Gauge Steel
- Powder Coated Paint Finish with Clear Gloss Finish
- Solid Steel Weight Plates, Hard Chrome guides rods, Low Friction bushings
- Fixed pulley low cable row
- Angled seat and footplates for bio mechanically correct position
- Full Weight Stack Shrouds
- Dimensions: 890 x 2180 x 2266 mm (L x W x H) 35" L x 85.8" W x 89.2" H
- *Machine Weight : 180Kg / 397 lbs*
- *Standard Weight Stack : 100 kg / 220 lbs (Optional Max Stack Weight : 140 kg / 308 lbs)*



# TWMA 305 Lat Pull Down

## KEY FEATURES

- 2" x 4" Square Tubing 9 Gauge Steel
- Powder Coated Paint Finish with Clear Gloss Finish
- Solid Steel Weight Plates, Hard Chrome guides rods, Low Friction bushings
- Adjustable round hold down pads for stability
- Full Weight Stack Shrouds
- Dimensions: 1180 x 1430 x 2267 mm (L x W x H) 46.4" L x 56.2" W x 89.2" H
- *Machine Weight : 170Kg / 374 lbs*
- *Standard Weight Stack : 100 kg / 220 lbs (Optional Max Stack Weight : 140 kg / 308 lbs)*







## TWMA 331 Long Pull - Lat Pull Down **DUAL**

### KEY FEATURES

- 2" x 4" Square Tubing 9 Gauge Steel
- Powder Coated Paint Finish with Clear Gloss Finish
- Solid Steel Weight Plates, Hard Chrome guides rods, Low Friction bushings
- Adjustable round hold down pads for stability
- Full Weight Stack Shrouds
- Dimensions: 2031 x 1199 x 2266 mm (L x W x H) 79.9" L x 47.2" W x 89.2" H
- *Machine Weight : 116Kg / 255lbs*
- *Standard Weight Stack : 100 kg / 220 lbs (Optional Max Stack Weight : 140 kg / 308 lbs)*



## TWMA 306 Butter Fly (Pec Fly)

### KEY FEATURES

- 2" x 4" Square Tubing 9 Gauge Steel
- Powder Coated Paint Finish with Clear Gloss Finish
- Solid Steel Weight Plates, Hard Chrome guides rods, Low Friction bushings
- Adjustable starting range of motion
- Arm Pad and Handle Bar Pivot adjusts to the users path of motion
- Easy seat adjustment ratcheting system
- Full Weight Stack Shrouds
- Dimensions: 976 x 1364 x 2102 mm (L x W x H) 38.4" L x 53.7" W x 82.7" H
- *Machine Weight : 185Kg / 408 lbs*
- *Standard Weight Stack : 100 kg / 220 lbs (Optional Max Stack Weight : 140 kg / 308 lbs)*





## TWMA 308 Assist Chin - Dip **DUAL**

### KEY FEATURES

- 2" x 4" Square Tubing 9 Gauge Steel
- Powder Coated Paint Finish with Clear Gloss Finish
- Solid Steel Weight Plates, Hard Chrome guides rods, Low Friction bushings
- Knee Pad body position for assisted movements folds under for body weight movements
- Multi Grip Chin Up Handles
- Dip Bars adjust in width for user size and muscle isolation
- Full Weight Stack Shrouds
- Dimensions: 1138 x 1284 x 2169 mm (L x W x H) 44.8" L x 50.5" W x 85.3" H
- *Machine Weight : 180Kg / 397 lbs*
- *Standard Weight Stack : 75 kg / 165 lbs*

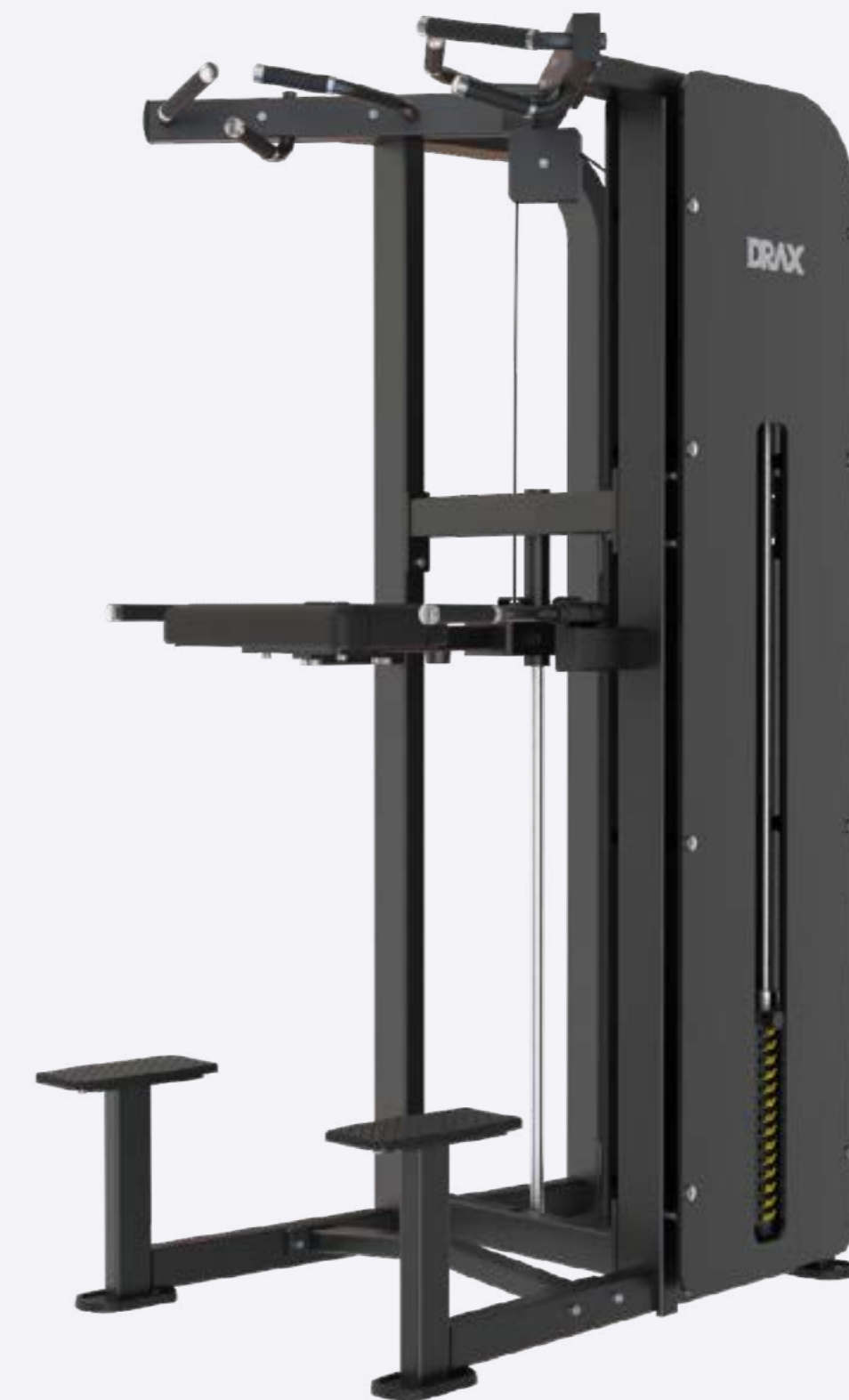

## TWMA 309 Arm Curl

### KEY FEATURES

- 2" x 4" Square Tubing 9 Gauge Steel
- Powder Coated Paint Finish with Clear Gloss Finish
- Solid Steel Weight Plates, Hard Chrome guides rods, Low Friction bushings
- Counterbalanced for lighter starting weight
- Angled Arm Pad & Movement Arm for Bicep Isolation
- Easy seat adjustment ratcheting system
- Full Weight Stack Shrouds
- Dimensions: 1063 x 1306 x 1552 mm (L x W x H) 41.8" L x 51.4" W x 61.1" H
- *Machine Weight : 170Kg / 375 lbs*
- *Standard Weight Stack : 100 kg / 220 lbs (Optional Max Stack Weight : 140 kg / 308 lbs)*





## TWMA 310 Pec Fly - Rear Delt **DUAL**

### KEY FEATURES

- 2" x 4" Square Tubing 9 Gauge Steel
- Powder Coated Paint Finish with Clear Gloss Finish
- Solid Steel Weight Plates, Hard Chrome guides rods, Low Friction bushings
- Allows for forward Pec Fly & rearward Rear Delt
- Adjustable starting range of motion
- Arm Handle Bar Pivot adjusts to the users path of motion
- Easy seat adjustment ratcheting system
- Full Weight Stack Shrouds
- Dimensions: 1419 x 1286 x 2107 mm (L x W x H) 55.8" L x 50.6" W x 83" H
- *Machine Weight : 185Kg / 407 lbs*
- *Standard Weight Stack : 100 kg / 220 lbs (Optional Max Stack Weight : 140 kg / 308 lbs)*



# TWMA 311 Seated Row

## KEY FEATURES

- 2" x 4" Square Tubing 9 Gauge Steel
- Powder Coated Paint Finish with Clear Gloss Finish
- Solid Steel Weight Plates, Hard Chrome guides rods, Low Friction bushings
- Multiple handle positions allow for upper back and middle back movement
- Chest pad adjusts for user arm length
- Easy seat adjustment ratcheting system
- Full Weight Stack Shrouds
- Dimensions: 858 x 1288 x 1940 mm (L x W x H) 33.7" L x 50.7" W x 76.3" H
- *Machine Weight : 180Kg / 397 lbs*
- *Standard Weight Stack : 100 kg / 220 lbs (Optional Max Stack Weight : 140 kg / 308 lbs)*





# TWMA 312 Incline Chest Press

## KEY FEATURES

- 2" x 4" Square Tubing 9 Gauge Steel
- Powder Coated Paint Finish with Clear Gloss Finish
- Solid Steel Weight Plates, Hard Chrome guides rods, Low Friction bushings
- Easy seat adjustment ratcheting system
- Full Weight Stack Shrouds
- Dimensions: 1414 x 1122 x 1740 mm (L x W x H) 55.6" L x 44.1" W x 68.5" H
- *Machine Weight : 120Kg / 264 lbs*
- *Standard Weight Stack : 100 kg / 220 lbs (Optional Max Stack Weight : 140 kg / 308 lbs)*



## TWMA 313 Seated Dip

### KEY FEATURES

- 2" x 4" Square Tubing 9 Gauge Steel
- Powder Coated Paint Finish with Clear Gloss Finish
- Solid Steel Weight Plates, Hard Chrome guides rods, Low Friction bushings
- Easy seat adjustment ratcheting system
- Full Weight Stack Shrouds
- Dimensions: 1100 x 1023 x 1552 mm (L x W x H) 43.3" L x 40.2" W x 61.1" H
- *Machine Weight : 110Kg / 242 lbs*
- *Standard Weight Stack : 100 kg / 220 lbs (Optional Max Stack Weight : 140 kg / 308 lbs)*





# TWMA 401 Cable Cross Over

## KEY FEATURES

- 2" x 4" Square Tubing 9 Gauge Steel
- Powder Coated Paint Finish with Clear Gloss Finish
- Solid Steel Weight Plates, Hard Chrome guides rods, Low Friction bushings
- Adjustable height pulley adjustments with single hand design
- Multi grip chin up handles
- Rear Weight Stack Shrouds
- Dimensions: 3505 x 1180 x 2370 mm mm (L x W x H) 138" L x 46.4" W x 93.3" H
- *Machine Weight : 60Kg / 1,014 lbs*
- *Standard Weight Stack : 2 EA x 100 kg / 220 lbs*



# TWMA 402 Dual Pulley

## KEY FEATURES

- 2" x 4" Square Tubing 9 Gauge Steel
- Powder Coated Paint Finish with Clear Gloss Finish
- Solid Steel Weight Plates, Hard Chrome guides rods, Low Friction bushings
- Adjustable height pulley adjustments with single hand design
- 1:4 Lifting Ratio allows for lighter starting weights and high speed athletic movements
- Multi grip chin up handles
- Full Weight Stack Shrouds
- Dimensions: 1623 x 1079 x 2340 mm (L x W x H) 63.8" L x 42.4" W x 92.1" H
- *Machine Weight : 500Kg / 1,102 lbs*
- *Standard Weight Stack : 2 EA x 140 kg / 308 lbs*



# Standard Strength Equipment Colors

✦ Warranty 2 yrs, Wear items 6 months

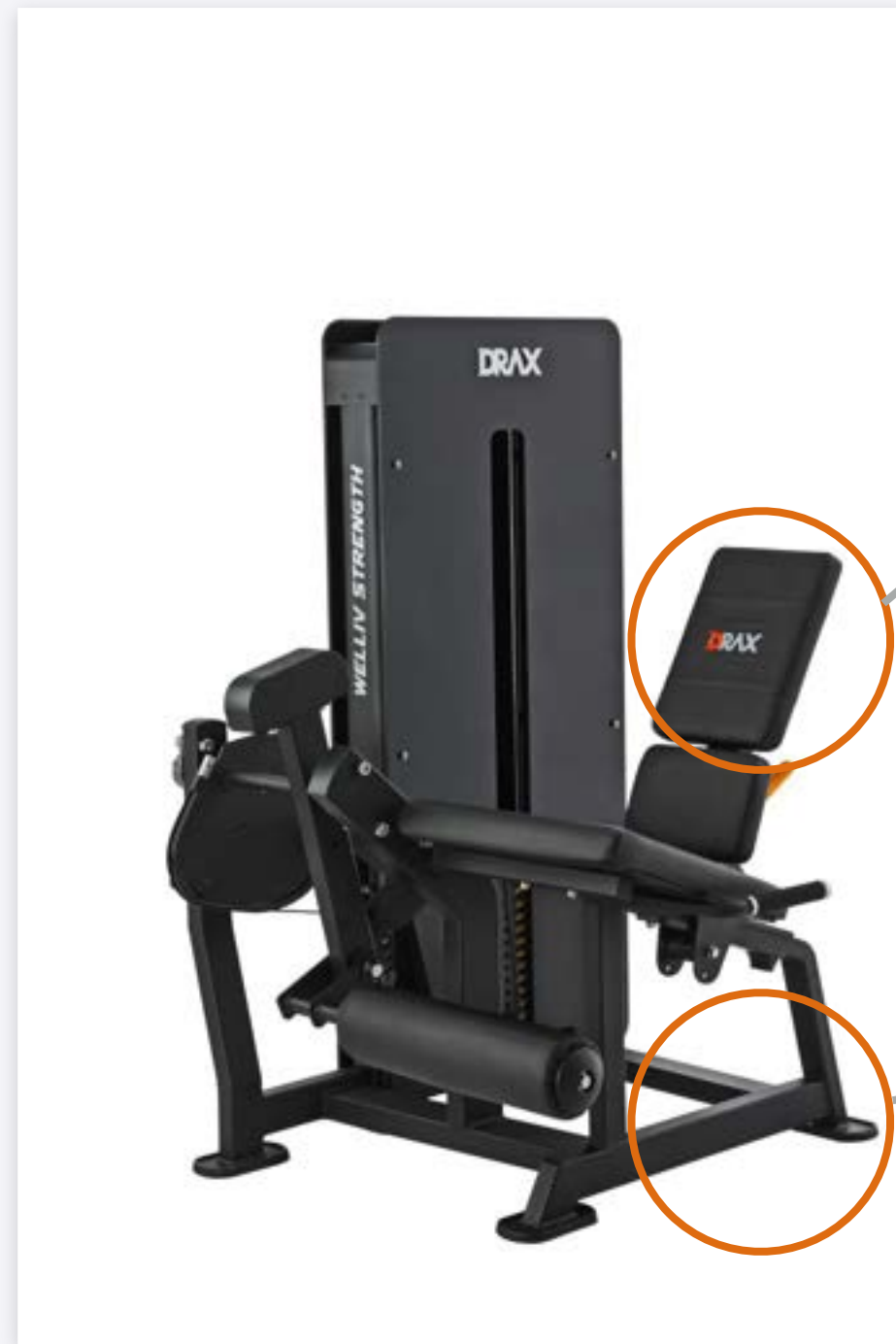

## Upholstery Color

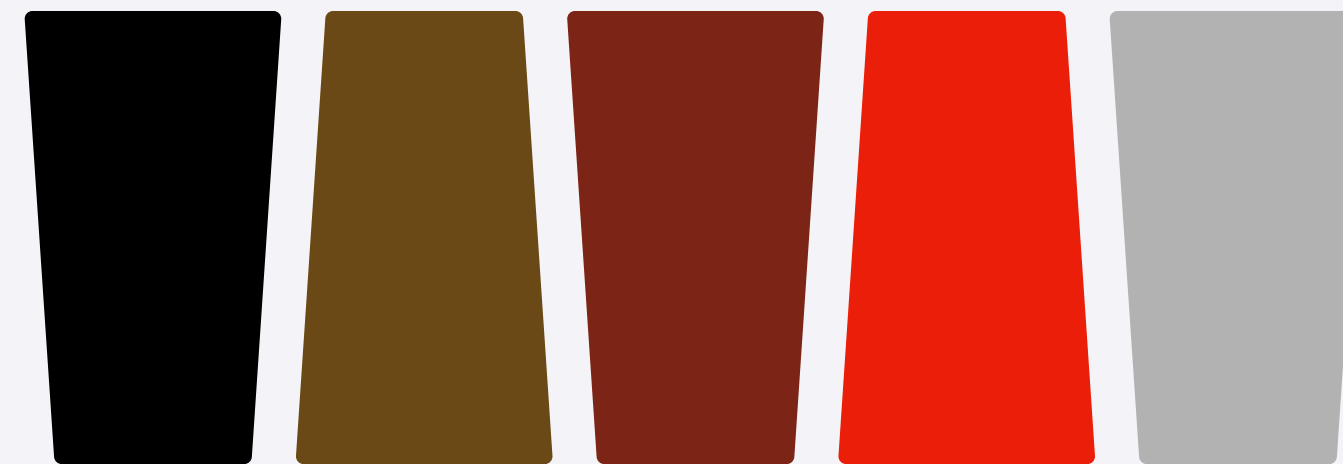

Black    Brown    Wine    Red    Silver

## Frame Color



Black    White    Dark Charcoal    Red    Yellow

## *Wooden Cover (pure walnut, optional)*

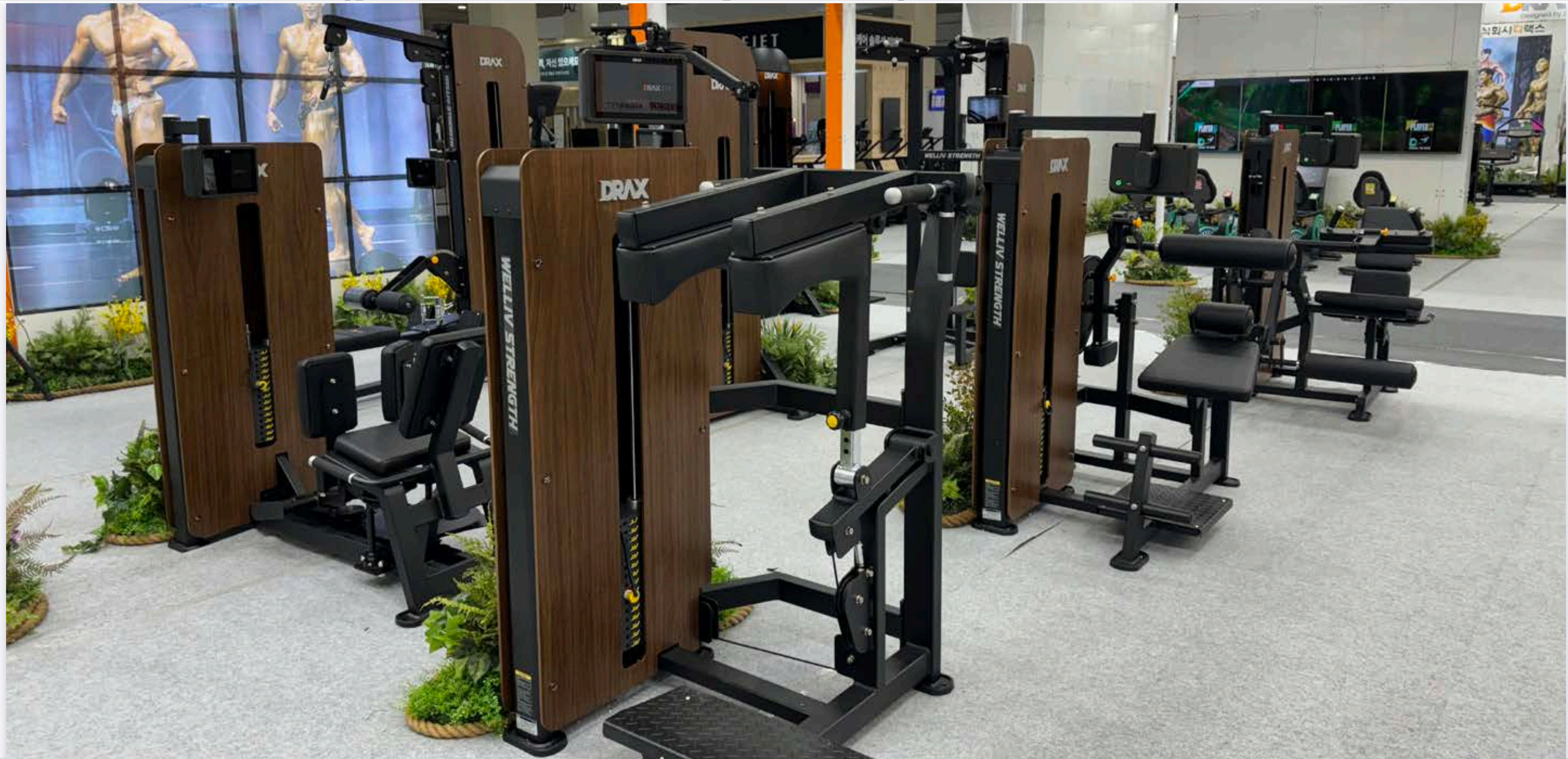

# DRAX PURE PLATE

DRAX PUREPLATE SERIES

PRODUCT SPECIFICATION

# DRAX

Designed by Science





PPRP 101

PPRP - 101

# ROTARY PULLDOWN

## Product Specification

- Movement Trajectory : Outer-Upper to Inner-Lower
- Grip : Parallel & Wide Grip
- Proven optimal movement trajectory considering the natural movement of the scapula and humerus
- Space-efficient size
- Leverage loading that combines the advantages of Pin Loaded and Plate Loaded

Dimension 1086.9 x 1250.9 x 2044.6 mm (W x L x H)

Weight 130 Kg

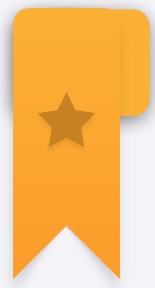

PPHR 102

PPHR - 102

# HIGH ROW

## Product Specification

- Movement Trajectory : Anterior-Upper to Posterior-Lower
- Grip : Free Motion Grip
- Optimal motion trajectory with proven resistance design that guides maximum relaxation and contraction of latissimus dorsi muscle
- Space-efficient size
- Leverage loading that combines the advantages of Pin Loaded and Plate Loaded

Dimension 1242.8 x 1940.3 x 2040.4 mm (W x L x H)

Weight 148 Kg



PPFR - 103

# FRONT ROW

## Product Specification

- Movement Trajectory : Anterior to Posterior
- Grip : Multi Grip
- Optimal muscle stimulation through various grips
- Optimal seat position with adjustable footrest and chest pad
- Optimal motion trajectory with proven resistance design
- Space-efficient size

PPFR 103

**DRAX PUREPLATE**

Dimension	1374.3 x 1401.8 x 1256 mm (W x L x H)
-----------	---------------------------------------

Weight	108 Kg
--------	--------



PPLR - 104

# LOW ROW

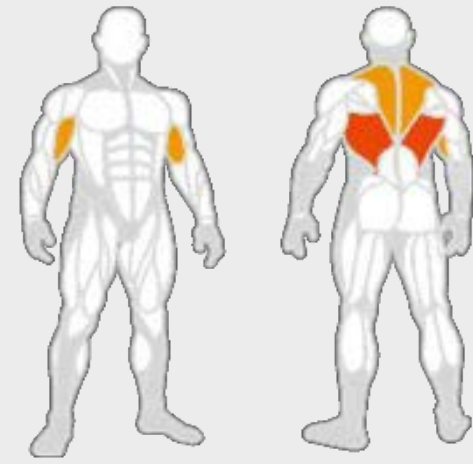

PPLR 104

DRAX PUREPLATE

## Product Specification

- Movement Trajectory : Anterior-Lower to Posterior-Upper
- Grip : Parallel Grip
- Optimal motion trajectory for back thickness advancement
- Space-efficient size
- Leverage loading that combines the advantages of Pin

Loaded and Plate Loaded

Dimension	1381.9 x 1449.5 x 1653.5 mm (W x L x H)
-----------	---

Weight	115 Kg
--------	--------



PPCP 105

PPCP - 105

# CHEST PRESS

## Product Specification

- Movement Trajectory : Lateral-Medial to Anterior
- Grip : Parallel & Standard Grip
- Ergonomic design for the best trajectory of the chest muscles
- Space-efficient size
- Leverage loading that combines the advantages of Pin Loaded and Plate Loaded

Dimension 1205.1 x 1230.3 x 1817.3 mm (W x L x H)

Weight 135 Kg



PPSP 106

PPSP - 106

# SHOULDER PRESS

## Product Specification

- Movement Trajectory : Lateral-Medial to Upper
- Grip : Parallel & Standard Grip
- Ergonomic design for stable movement of shoulder joint
- Optimal seat position with adjustable backrest and saddle
- Space-efficient size

Dimension	1540.7 x 1325.5 x 1282 mm (W x L x H)
-----------	---------------------------------------

Weight	90 Kg
--------	-------



PPVS - 107

# V-SQUAT

## Product Specification

- Movement Trajectory : Arc
- Ergonomic design for stable movement
- Optimal position Design
- Space-efficient size

PPSVS 107

**DRAX PUREPLATE**

Dimension	1892 x 1261 x 1723 mm (W x L x H)
-----------	-----------------------------------

Weight	140 Kg
--------	--------



PPSVS 107

PPLP - 108

# Power Leg Press

## Product Specification

- Movement Trajectory : Arc
- Ergonomic design for stable movement
- Optimal position Design
- Space-efficient size

Dimension	2244 x 1461 x 1650 mm (W x L x H)
-----------	-----------------------------------

Weight	250 Kg
--------	--------



PPHS - 109

# HACK SQUAT



PPSVS 107

### Product Specification

- Movement Trajectory : Arc
- Ergonomic design for stable movement
- Optimal position Design
- Space-efficient size

Dimension	1999 x 1498 x 1347 mm (W x L x H)
-----------	-----------------------------------

Weight	140 Kg
--------	--------



PPLR 110

PPLR - 110

# LATERAL RAISE

## Product Specification

- Ergonomic design for stable movement
- Optimal seat position
- Space-efficient size

Dimension	1151 x 1051 x 1250 mm (W x L x H)
Weight	75 Kg



PPHT - 111

# HIP THRUST

## Product Specification

- Ergonomic design for stable movement
- Optimal position Design
- Space-efficient size

Dimension	1165 x 1690 x 1076 mm (W x L x H)
Weight	100 Kg

**DRAX PUREPLATE**

PPSVS 107



## Drax Free Weight Equipment – TWF Series

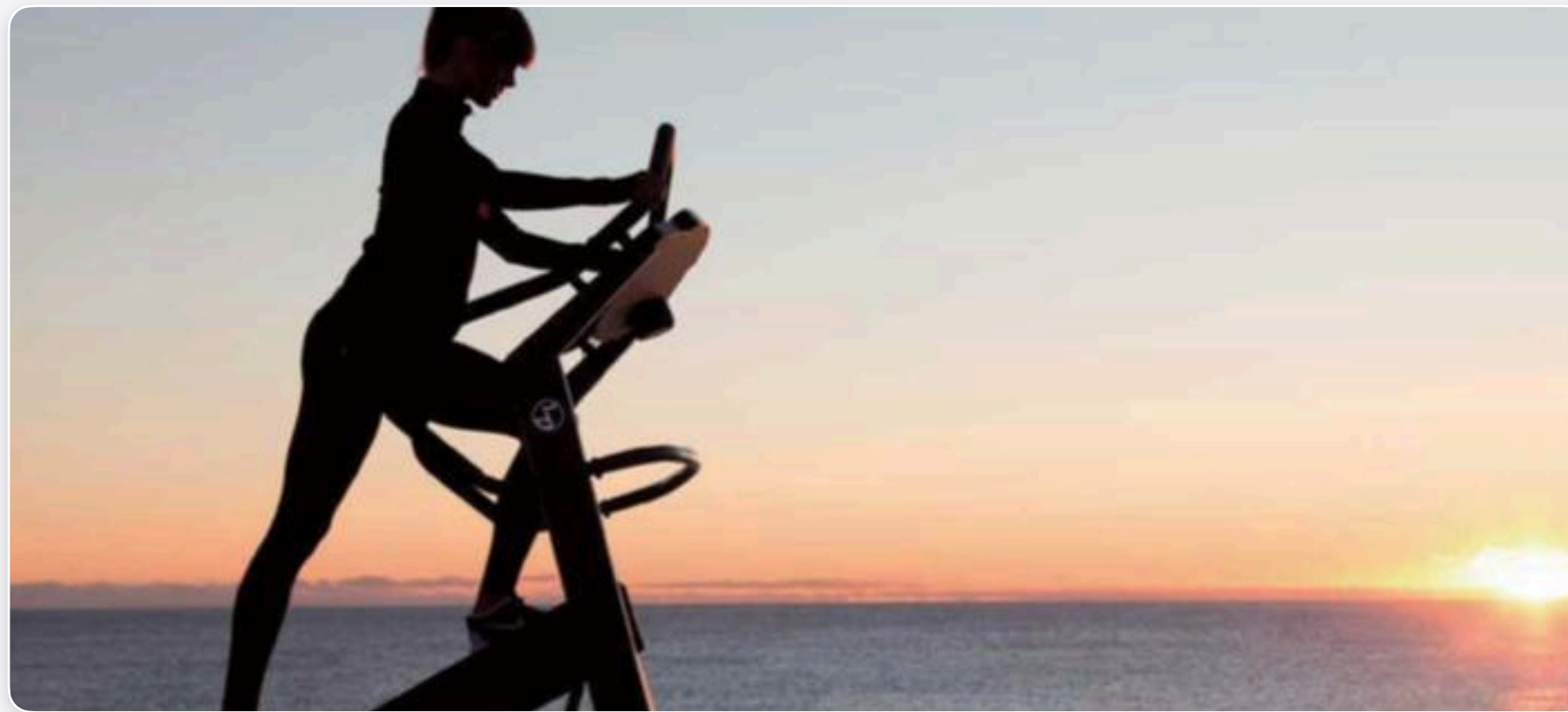



## TWF 104 Plated Loaded Flat Bench

### KEY FEATURES

- 2" x 4" Oval Tubing 9 Gauge Steel
- Powder Coated Paint Finish with Clear Gloss Finish
- Long seat allows you to exercise regardless of height
- Horizontal Flat Bench design
- Independent Iso lateral arm movements
- Dimensions: 1615 x 1370 x 946 mm (L x W x H) 63.5" L x 54" W x 37.2" H
- *Machine Weight : 90 Kg / 198 lbs*



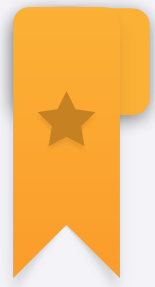

## TWF 105 Plated Loaded Incline Bench

### KEY FEATURES

- 2" x 4" Oval Tubing 9 Gauge Steel
- Powder Coated Paint Finish with Clear Gloss Finish
- Independent Iso lateral arm movements
- Adjustable Incline Bench angle
- Adjustable Seat Height
- Dimensions: 1605 x 1330 x 1150 mm (L x W x H) 63.1" L x 52.3" W x 45.2" H
- *Machine Weight : 100 Kg / 220 lbs*





## TWF 106 Plated Loaded Decline Bench

### KEY FEATURES

- 2" x 4" Oval Tubing 9 Gauge Steel
- Powder Coated Paint Finish with Clear Gloss Finish
- Independent Iso lateral arm movements
- Adjustable Incline Bench angle
- Dimensions: 2011 x 1359 x 938 mm (L x W x H) 79" L x 53.5" W x 37" H
- *Machine Weight : 100 Kg / 220 lbs*



## TWF 201 Flat Bench

### KEY FEATURES

- 2" x 4" Oval Tubing 9 Gauge Steel
- Powder Coated Paint Finish with Clear Gloss Finish
- Flat Bench for a variety of exercises
- Dimensions: 1170 x 780 x 425 mm (L x W x H) 46" L x 30" W x 16.7" H
- *Machine Weight : 13 Kg / 28.6 lbs*



# TWF 202 Olympic Flat Bench

## KEY FEATURES

- 2" x 4" Oval Tubing 9 Gauge Steel
- Powder Coated Paint Finish with Clear Gloss Finish
- Angled bar rack design for easy lift off and spotter access
- 2 Lift off positions on hard chrome racks protect paint finish
- Optional Weight Storage (sold separately)
- Dimensions: 1253 x 1280 x 1258 mm (L x W x H) 49.3" L x 50.3" W x 49.5" H
- *Machine Weight : 68 Kg / 150 lbs*



Optional Weight  
Storage

(TWF 210-5)

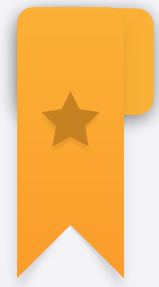

## TWF 203 Multi-Adjustable Bench

### KEY FEATURES

- 2" x 4" Oval Tubing 9 Gauge Steel
- Powder Coated Paint Finish with Clear Gloss Finish
- Single point adjustment changes seat back and seat pad simultaneously
- Adjusts from 0-80 degrees
- Transport handles and wheels for portability
- Dimensions: 1347 x 780 x 454 mm (L x W x H) 53" L x 30.7" W x 17.8" H
- *Machine Weight : 35 Kg / 77 lbs*



# TWF 204 Olympic Incline Bench

## KEY FEATURES

- 2" x 4" Oval Tubing 9 Gauge Steel
- Powder Coated Paint Finish with Clear Gloss Finish
- Angled bar rack design for easy lift off and spotter access
- 2 Lift off positions on hard chrome racks protect paint finish
- Optional Weight Storage (sold separately)
- Dimensions: 1501 x 1297 x 1397 mm (L x W x H) 59" L x 51" W x 55" H
- *Machine Weight : 70 Kg / 154 lbs*



Optional Weight Storage

(TWF 210-5)



# TWF 205 Olympic Decline Bench

## KEY FEATURES

- 2" x 4" Oval Tubing 9 Gauge Steel
- Powder Coated Paint Finish with Clear Gloss Finish
- Angled bar rack design for easy lift off and spotter access
- 2 Lift off positions on hard chrome racks protect paint finish
- Optional Weight Storage (sold separately)
- Dimensions: 1543 x 1296 x 1256 mm (L x W x H) 60.7" L x 51" W x 49.4" H
- *Machine Weight : 68 Kg / 150 lbs*



Optional Weight  
Storage

(TWF 210-5)



## TWF 206 Utility Bench

### KEY FEATURES

- 2" x 4" Oval Tubing 9 Gauge Steel
- Powder Coated Paint Finish with Clear Gloss Finish
- 80 degree angles backrest
- Open footprint design for easy access
- Dimensions: 890 x 660 x 898 mm (L x W x H) 35" L x 26" W x 35.3" H
- *Machine Weight : 23 Kg / 50 lbs*





## TWF 209 Adjustable Decline Bench

### KEY FEATURES

- 2" x 4" Oval Tubing 9 Gauge Steel
- Powder Coated Paint Finish with Clear Gloss Finish
- Adjustable angled pad
- Comfortable Roller pad design
- Assist handle for easy access and reverse leg raise movements
- Transport handle and wheels for portability
- Dimensions: 1531 x 780 x 871 mm (L x W x H) 60.2" L x 30.7" W x 34.2" H
- *Machine Weight : 45 Kg / 99.2 lbs*





# TWF 210 Supine Olympic Bench

## KEY FEATURES

- 2" x 4" Oval Tubing 9 Gauge Steel
- Powder Coated Paint Finish with Clear Gloss Finish
- Angled bar rack design for easy lift off and spotter access
- 2 Lift off positions on hard chrome racks protect paint finish
- Dimensions: 1745 x 1740 x 1258 mm (L x W x H) 68.7" L x 68.5" W x 49.5" H
- *Machine Weight : 72 Kg / 158.7 lbs*





## TWF 211 Standing Arm Curl

### KEY FEATURES

- 2" x 4" Oval Tubing 9 Gauge Steel
- Powder Coated Paint Finish with Clear Gloss Finish
- Two pad angles provide different arm curl positions
- Bar rests have protective guards to protect bars and paint finish
- Dimensions: 900 x 1200 x 1086 mm (L x W x H) 35.4" L x 47.2" W x 42.7" H
- *Machine Weight : 50 Kg / 110 lbs*





# TWF 213 Back Hyper Extension Bench

## KEY FEATURES

- 2" x 4" Oval Tubing 9 Gauge Steel
- Powder Coated Paint Finish with Clear Gloss Finish
- Adjustable angle increases or decreases the difficulty
- Adjustable pad height for proper user fit
- Dimensions: 1266 x 835 x 712 mm (L x W x H) 49.8" L x 32.8" W x 28" H
- *Machine Weight : 35 Kg / 77 lbs*





## TWF 214 T-Bar Row

### KEY FEATURES

- 2" x 4" Oval Tubing 9 Gauge Steel
- Powder Coated Paint Finish with Clear Gloss Finish
- Footplate guards protect surface and increase foot traction
- Floating straight resistance bar allows for full range of motion
- Dimensions: 1854 x 761 x 392 mm (L x W x H) 73" L x 30" W x 15.4" H
- *Machine Weight : 20 Kg / 44 lbs*



# TWF 302 Power Rack

## KEY FEATURES

- 2" x 4" Square Tubing 9 Gauge Steel
- Powder Coated Paint Finish with Clear Gloss Finish
- Notched uprights provide secure and quick adjustments for bar catches and safety rails
- Includes 8 weight storage horns
- Multi Grip Chin Up handles
- Straight Chin Up Bar
- Includes 2 ea Vertical Bar Storage Hooks and Band Hooks
- Dimensions: 1916 x 1740 x 2316 mm (L x W x H) 75.4" L x 68.5" W x 91.1" H
- *Machine Weight : 150 Kg / 330 lbs*
- Max User Weight : 159 Kg / 350 lbs
- Max Training Weight : 225 Kg / 496 lbs







# TWF 303 Olympic Squat Rack

## KEY FEATURES

- 2" x 4" Oval Tubing 9 Gauge Steel
- Powder Coated Paint Finish with Clear Gloss Finish
- Olympic squat rack with 5 fixed lift off positions
- Includes 8 weight storage horns
- Fixed safety rails
- Dimensions: 1724 x 1755 x 1889 mm (L x W x H) 67.8" L x 69" W x 74.3" H
- *Machine Weight : 110 Kg / 242.5 lbs*





## TWF 304 VKR Dip & Chin

### KEY FEATURES

- 2" x 4" Oval Tubing 9 Gauge Steel
- Powder Coated Paint Finish with Clear Gloss Finish
- Angled pad design for comfort and proper body position
- Multi Grip Chin Up & Dip Handles
- Assist Step Up braces
- Dimensions: 1254 x 1128 x 2284 mm (L x W x H) 49.3" L x 44.4" W x 89.8" H
- *Machine Weight : 64 Kg / 141 lbs*





# TWF 305 Multi Rack

## KEY FEATURES

- 2" x 4" Square Tubing 9 Gauge Steel
- Powder Coated Paint Finish with Clear Gloss Finish
- Multi rack design incorporates Olympic Half Rack and Smith Machine
- Notched uprights provide secure and quick adjustments for bar catches and safety rails
- Includes 12 weight storage horns
- Multi Grip Chin Up handles
- Straight Chin Up Bar
- Includes 2 ea Vertical Bar Storage Hooks and Band Hooks
- Linear bearing counter balanced bar with 10 lbs starting resistance
- Dimensions: 2024 x 2209 x 2334 mm (L x W x H) 79.6" L x 86.9" W x 91.8" H
- *Machine Weight : 180 Kg / 396.9 lbs*
- Max User Weight : 159 Kg / 350 lbs
- Max Training Weight : 225 Kg / 496 lbs



# TWF 308 Half Rack

## KEY FEATURES

- 2" x 4" Square Tubing 9 Gauge Steel
- Powder Coated Paint Finish with Clear Gloss Finish
- Notched uprights provide secure and quick adjustments for bar catches and safety rails
- Includes 12 weight storage horns
- Multi Grip Chin Up handles
- Includes 2 ea Vertical Bar Storage Hooks and Band Hooks
- Dimensions: 1466 x 1807 x 2327 mm (L x W x H) 57.7" L x 71.1" W x 91.6" H
- *Machine Weight : 120 Kg / 264.6 lbs*
- Max User Weight : 159 Kg / 350 lbs
- Max Training Weight : Bolted to Floor 225 Kg / 496 lbs /Free Standing 145 Kg / 320 lbs





## TWF 402 2-Tier Dumbbell Rack

### KEY FEATURES

- 2" x 4" Oval Tubing 9 Gauge Steel
- Powder Coated Paint Finish with Clear Gloss Finish
- 10 pr 2 Tier design with protective saddles
- Dimensions: 598 x 2295 x 825 mm (L x W x H) 23.5" L x 90.3" W x 32.4" H
- *Machine Weight : 35 Kg / 77 lbs*





# TWF 403 Olympic Weight Tree

## KEY FEATURES

- 2" x 4" Oval Tubing 9 Gauge Steel
- Powder Coated Paint Finish with Clear Gloss Finish
- 6 Weight Horns on free standing frame
- Dimensions: 750 x 595 x 926 mm (L x W x H) 29.5" L x 23.4" W x 36.4" H
- *Machine Weight : 22 Kg / 48.5 lbs*





## TWF 404 Fixed Barbell Rack

### KEY FEATURES

- 2" x 4" Oval Tubing 9 Gauge Steel
- Powder Coated Paint Finish with Clear Gloss Finish
- A Frame design holds 10 fixed barbells
- Hard chrome storage pegs and protective wear guards on frame
- Dimensions: 1020 x 840 x 1392 mm (L x W x H) 40.1" L x 33" W x 54.8" H
- *Machine Weight : 30 Kg / 66 lbs*





## TWF 406 Ab Twist

### KEY FEATURES

- 2" x 4" Oval Tubing 9 Gauge Steel
- Powder Coated Paint Finish with Clear Gloss Finish
- Standing twist movement on rotational footplate
- Seated position for stationary rotation assist
- Dimensions: 1305 x 660 x 1276 mm (L x W x H) 51.3" L x 26" W x 50.2" H
- *Machine Weight : 30 Kg / 66 lbs*





# TWF 501 Linear Leg Press

## KEY FEATURES

- 2" x 4" Oval Tubing 9 Gauge Steel
- Powder Coated Paint Finish with Clear Gloss Finish
- Heavy Duty carriage travels on linear bearings over guide rods
- Adjustable back pad and large footplate
- Assist handle for easy entry and exit
- Two adjustable start positions
- 4 Olympic Weight Storage Horns
- Dimensions: 2432 x 1411 x 1342 mm (L x W x H) 95.7" L x 55.5" W x 52.8" H
- *Machine Weight : 178 Kg / 392 lbs*
- Max Training Weight : 650 Kg / 1,433 lbs





# TWF 601 Sit Up Bench (single) TWF 602 Sit Up Bench (double)

## KEY FEATURES

- 2" x 4" Oval Tubing 9 Gauge Steel
- Powder Coated Paint Finish with Clear Gloss Finish
- Assist handle for easy entry and exit
- Dimensions: 2134 x 705 x 1192 mm (L x W x H) (single)

2134 x 1270 x 1192 mm (L x W x H) (double)

- *Machine Weight : 25kg (single)*

*45kg (double)*





# TWF 701 Smith Machine

## KEY FEATURES

- 2" x 4" Square Tubing 9 Gauge Steel
- Powder Coated Paint Finish with Clear Gloss Finish
- Linear bearing counter balanced Smith Machine
- Adjustable starting positions and safety stops
- Linear bearing counter balanced bar with 10 lbs starting resistance
- 7 degree angle for proper path of motion for presses and squats
- Dimensions: 1267 x 2215 x 2240 mm (L x W x H) 50" L x 87.2" W x 88" H
- *Machine Weight : 160 Kg / 353 lbs*
- Max Training Weight : 240 Kg / 530 lbs



# DRAX Plates

CPU. 1.25, 2.5, 5, 7.5, 10, 15, 20, 25kg



# DRAX Dumbbells

CPU. 1,2,3,4,5,6,7,8,9, 10,12,14,16,18,20,22,24,26,28,30,32,34,36,38,40,42,44,46,48,50kg



# DRAX Fixed Barbells

CPU. 10,15,20,25,30kg (Straight Bar & Curl Bar 2 types)

